



# LX-15

Roland Digital Piano

Owner's Manual

# Roland

**WARNING:** To reduce the risk of fire or electric shock, do not expose this apparatus to rain or moisture.

 <b>CAUTION</b> RISK OF ELECTRIC SHOCK DO NOT OPEN	
<b>ATTENTION:</b> RISQUE DE CHOC ELECTRIQUE NE PAS OUVRIR	
<b>CAUTION:</b> TO REDUCE THE RISK OF ELECTRIC SHOCK, DO NOT REMOVE COVER (OR BACK). NO USER-SERVICEABLE PARTS INSIDE. REFER SERVICING TO QUALIFIED SERVICE PERSONNEL.	



The lightning flash with arrowhead symbol, within an equilateral triangle, is intended to alert the user to the presence of uninsulated "dangerous voltage" within the product's enclosure that may be of sufficient magnitude to constitute a risk of electric shock to persons.



The exclamation point within an equilateral triangle is intended to alert the user to the presence of important operating and maintenance (servicing) instructions in the literature accompanying the product.

INSTRUCTIONS PERTAINING TO A RISK OF FIRE, ELECTRIC SHOCK, OR INJURY TO PERSONS.

## IMPORTANT SAFETY INSTRUCTIONS SAVE THESE INSTRUCTIONS

**WARNING** - When using electric products, basic precautions should always be followed, including the following:

1. Read these instructions.
2. Keep these instructions.
3. Heed all warnings.
4. Follow all instructions.
5. Do not use this apparatus near water.
6. Clean only with a dry cloth.
7. Do not block any of the ventilation openings. Install in accordance with the manufacturers instructions.
8. Do not install near any heat sources such as radiators, heat registers, stoves, or other apparatus (including amplifiers) that produce heat.
9. Do not defeat the safety purpose of the polarized or grounding-type plug. A polarized plug has two blades with one wider than the other. A grounding type plug has two blades and a third grounding prong. The wide blade or the third prong are provided for your safety. If the provided plug does not fit into your outlet, consult an electrician for replacement of the obsolete outlet.
10. Protect the power cord from being walked on or pinched particularly at plugs, convenience receptacles, and the point where they exit from the apparatus.
11. Only use attachments/accessories specified by the manufacturer.
12. Use only with the cart, stand, tripod, bracket, or table specified by the manufacturer, or sold with the apparatus. When a cart is used, use caution when moving the cart/apparatus combination to avoid injury from tip-over.
13. Unplug this apparatus during lightning storms or when unused for long periods of time.
14. Refer all servicing to qualified service personnel. Servicing is required when the apparatus has been damaged in any way, such as power-supply cord or plug is damaged, liquid has been spilled or objects have fallen into the apparatus, the apparatus has been exposed to rain or moisture, does not operate normally, or has been dropped.



For the U.K.

**IMPORTANT:** THE WIRES IN THIS MAINS LEAD ARE COLOURED IN ACCORDANCE WITH THE FOLLOWING CODE.

BLUE: NEUTRAL  
BROWN: LIVE

As the colours of the wires in the mains lead of this apparatus may not correspond with the coloured markings identifying the terminals in your plug, proceed as follows:  
The wire which is coloured BLUE must be connected to the terminal which is marked with the letter N or coloured BLACK.  
The wire which is coloured BROWN must be connected to the terminal which is marked with the letter L or coloured RED.  
Under no circumstances must either of the above wires be connected to the earth terminal of a three pin plug.

Before using this unit, carefully read the sections entitled: "IMPORTANT SAFETY INSTRUCTIONS", "USING THE UNIT SAFELY" (p. 55), and "IMPORTANT NOTES" (p. 56). These sections provide important information concerning the proper operation of the unit. Additionally, in order to feel assured that you have gained a good grasp of every feature provided by your new unit, Owner's manual should be read in its entirety. The manual should be saved and kept on hand as a convenient reference.



# Contents

<b>Look What You Can Do!</b> .....	<b>4</b>	Copying a Saved Song (Copy Song) .....	<b>41</b>
<b>Operation Guide</b> .....	<b>6</b>	Deleting a Saved Song (Delete Song) .....	<b>42</b>
<b>Panel Descriptions</b> .....	<b>10</b>	Initializing the Memory (Format Media) .....	<b>42</b>
<b>Before You Play</b> .....	<b>12</b>	Disabling the Buttons (Panel Lock) .....	<b>43</b>
Opening/Closing the Lid .....	<b>12</b>	<b>Various Settings (Function Mode)</b> .....	<b>44</b>
Opening/Closing the Top Lid .....	<b>12</b>	Making the Power Automatically Turn Off After a Time (Auto Off) (p. 40) ..	<b>44</b>
Turning the Power On/Off .....	<b>13</b>	Matching the Pitch with Other Instruments (Master Tuning) .....	<b>44</b>
<b>Performing</b> .....	<b>14</b>	Changing the Tuning Method (Temperament) .....	<b>44</b>
Performing with Various Sounds .....	<b>14</b>	Specifying a Song's Tonic (Temperament Key) .....	<b>44</b>
Switching Tones .....	<b>14</b>	Adjusting the Dual Play Volume Balance (Dual Balance) .....	<b>44</b>
Performing with Two Layered Tones (Dual Play) .....	<b>15</b>	Adjusting the Volume (Master Gain) .....	<b>44</b>
Playing Different Tones with the Right and Left Hands (Split Play) .....	<b>16</b>	Adjusting the Volume of an Audio Playback Device (Input Volume) .....	<b>44</b>
Adjusting the Sound to Your Taste .....	<b>18</b>	Playing Back an Audio File with Its Central Sound Minimized (Center Cancel) .....	<b>45</b>
Adding Reverberation to the Sound (Ambience) .....	<b>18</b>	Transposing an Audio File (Audio Transpose) .....	<b>45</b>
Adjusting the Brightness of the Sound (Brilliance) .....	<b>19</b>	Specifying What the Transpose will Affect (Transpose Mode) .....	<b>45</b>
Adjusting the Keyboard Response (Key Touch) .....	<b>19</b>	Changing the Pitch of the Tone in Octave Steps (Octave Shift) .....	<b>45</b>
Dividing the Keyboard for Two-person Performance (Twin Piano) .....	<b>20</b>	Selecting the Format for Recording (Recording Mode) .....	<b>45</b>
Shifting the Pitch (Transpose) .....	<b>21</b>	Changing How the Pedal Effects Are Applied (Damper Pedal Part) .....	<b>45</b>
<b>Practicing</b> .....	<b>22</b>	Changing How the Pedals Work (Center Pedal) .....	<b>46</b>
Practicing with the Metronome .....	<b>22</b>	Preventing Doubled Notes When Connected to a Sequencer (Local Control) .....	<b>46</b>
Changing the Tempo .....	<b>22</b>	MIDI Transmit Channel Settings (MIDI Transmit Channel) .....	<b>46</b>
Changing the Time Signature .....	<b>22</b>	Setting the Type of CD to be Played Back (CD/Audio Type) .....	<b>47</b>
Adjusting the Metronome's Volume .....	<b>23</b>	Saving an Internal Song (Save Song) (p. 37) .....	<b>47</b>
Adding a Count-in to Synchronize Your Performance .....	<b>23</b>	Copying a Saved Song (Copy Song) (p. 41) .....	<b>47</b>
Practicing with a Song .....	<b>24</b>	Deleting a Saved Song (Delete Song) (p. 42) .....	<b>47</b>
Selecting and Playing a Song .....	<b>24</b>	Initializing the Memory (Format Media) (p. 42) .....	<b>47</b>
Playing Songs Consecutively (All Songs Play) .....	<b>25</b>	Changing the USB Driver Settings (USB Driver) .....	<b>47</b>
Adjusting the Volume Balance of the Song and the Keyboard Performance (Song Balance) .....	<b>25</b>	Changing the USB flash drive Setting (USB Memory Mode) .....	<b>48</b>
Adjusting a Song's Tempo for Easier Practicing .....	<b>25</b>	Controlling Video Equipment (Visual Control Mode) .....	<b>48</b>
Practicing One Hand at a Time (Part Mute) .....	<b>26</b>	Specifying the Visual Control Channel (Visual Control Channel) .....	<b>48</b>
Repeatedly Practicing a Portion of a Song (AB Repeat) .....	<b>27</b>	Adjusting the Brightness of the Display (Display Contrast) (p. 40) .....	<b>49</b>
Recording the Song You're Practicing .....	<b>28</b>	Storing Your Settings (Memory Backup) (p. 40) .....	<b>49</b>
SMF Recording .....	<b>28</b>	Restoring the Factory Settings (Factory Reset) (p. 41) .....	<b>49</b>
Overdubbing a Recorded Song .....	<b>30</b>	<b>Troubleshooting</b> .....	<b>50</b>
Converting a Song Recorded as an SMF to Audio .....	<b>33</b>	<b>Tone List</b> .....	<b>52</b>
Audio Recording .....	<b>34</b>	<b>Internal Song List</b> .....	<b>53</b>
Transposing a Song for Easier Performance (Audio Transpose) .....	<b>35</b>	<b>Main Specifications</b> .....	<b>54</b>
Using a Digital Audio Player Song to Enjoy Karaoke (Center Cancel) .....	<b>35</b>	<b>USING THE UNIT SAFELY</b> .....	<b>55</b>
Burning an Audio Recording of a Song (WAV file) to a CD .....	<b>36</b>	<b>IMPORTANT NOTES</b> .....	<b>56</b>
Saving an Internal Song .....	<b>37</b>	<b>About the Ivory Feel Keyboard</b> .....	<b>57</b>
<b>Personalizing Your Piano Sound (Piano Designer)</b> .....	<b>38</b>	<b>Assembling</b> .....	<b>58</b>
Making Detailed Adjustments to the Piano Sound .....	<b>38</b>	<b>Index</b> .....	<b>60</b>
<b>Convenient Functions</b> .....	<b>40</b>	<b>Error Messages</b> .....	<b>60</b>
Adjusting the Brightness of the Display (Display Contrast) .....	<b>40</b>		
Making the Power Automatically Turn Off After a Time (Auto Off) .....	<b>40</b>		
Retaining the Settings Even After Power-off (Memory Backup) .....	<b>40</b>		
Restoring the Factory Settings (Factory Reset) .....	<b>41</b>		

## How to read the explanatory illustrations

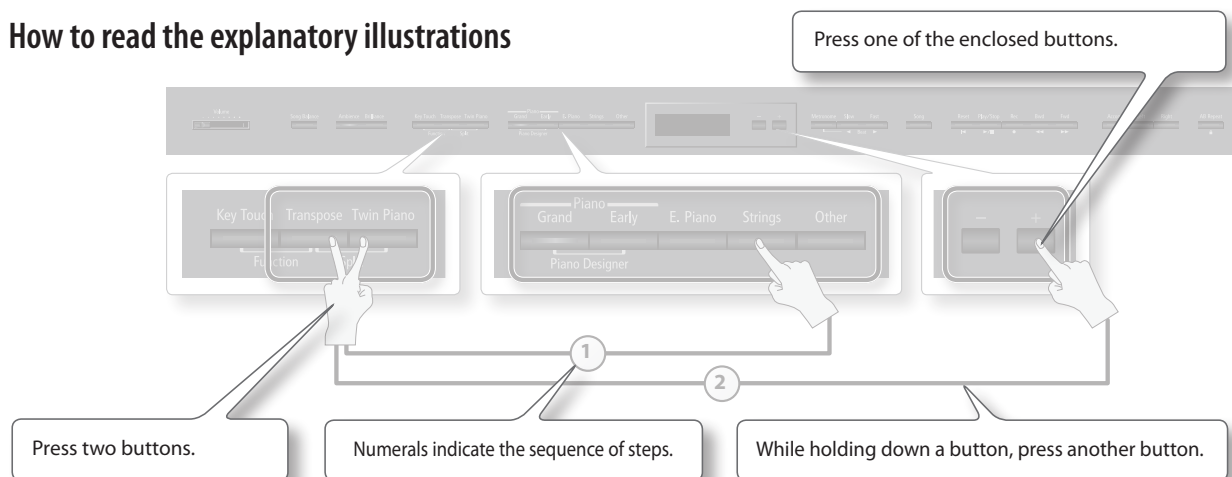

# Look What You Can Do!

## Play the Piano

### Play various sounds

page 14

The LX-15 contains a wide variety of tones (sounds).  
You can freely select and perform using these tones.

### Play two layered tones

page 15

You can layer two tones on a single key.

### Play different tones with your left and right hands

page 16

You can divide the keyboard into left and right zones, and select a different tone for each zone.

### Play duets

page 20

You can divide the keyboard into left and right halves, playing it as though it were two pianos.

## Practice Songs

### Sound a metronome

page 22

You can sound a metronome.

### Practice along with the built-in songs

page 24

The LX-15 contains numerous built-in songs.  
For the song titles, refer to "Internal Song List" (p. 53).

### Practice each hand separately

page 26

You can practice along with a song while listening to only the right-hand or left-hand part play back.

## Record Songs

### Record your performances

page 28

You can record your own playing.

### Use your computer to create a CD of a song you recorded

page 36

A song you've recorded can be copied to your computer, and written to a CD.

## Environmentally Friendly Energy-Efficient Design

### The power will turn off after a specified time has elapsed

page 40

When thirty minutes have elapsed since you last played or operated the LX-15, the power will turn off automatically.

\* If you don't want the power to turn off automatically, change the "Auto Off" setting (p. 40).



## Adjust Your Piano

### Adjust the keyboard touch page 19

You can adjust the touch sensitivity of the keyboard to match your own playing style.

### Add reverberation to the sound page 18

You can add reverberation (ambience) to create the sensation of performing in a concert hall.

### Adjust the brightness of the sound page 19

You can adjust the tone quality of the sound, ranging from a brilliant timbre to a mellow tone.



## Personalize Your Piano (Piano Designer)

### Adjust the openness of the grand piano's lid page 38

Closing the lid will produce a softer tone, and opening it will produce a brighter tone.

### Adjust the resonance of chords page 38

You can modify the resonance of chords by changing the way in which the piano's soundboard vibrates.

### Switch the temperament page 39

You can switch between various temperaments, such as historic temperaments used during the Baroque era.



## Convenient Functions

### Transpose the pitch of the keyboard or song page 21

The Transpose function lets you shift the pitch of the keyboard or a song so that you can perform more conveniently.

### Disable the buttons page 43

The Panel Lock function lets you prevent sounds or settings from being changed when buttons are pressed inadvertently.

# Operation Guide

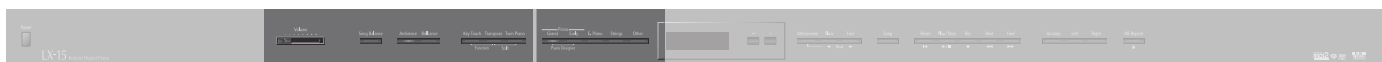

## Adding Reverberation (Ambience)

You can add a pleasant reverberation to the sounds, producing the impression that you are performing in a concert hall. **page 18**

### To turn ambience on

Press the [Ambience] button so it's lit.

### To adjust the ambience

While holding down the [Ambience] button, press the [-] [+] buttons.

## Adjusting the Brightness of the Sound (Brilliance)

You can adjust the brightness of the sound you play from the keyboard or the sounds of a song you play back. **page 19**

### To turn brilliance on

Press the [Brilliance] button so it's lit.

### To adjust the brilliance

While holding down the [Brilliance] button, press the [-] [+] buttons.

## Adjusting the Overall Volume

Adjust the sound's volume. **page 13**

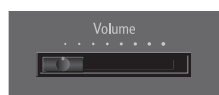

Min  $\longleftrightarrow$  Max

## Adjusting the Song Volume

### (Song Balance)

By modifying the playback volume of the song, you can adjust the balance between the song and your keyboard performance. **page 25**

### To turn song balance on

Press the [Song Balance] button so it's lit.

### To adjust the song balance

While holding down the [Song Balance] button, press the [-] [+] buttons.

## Adjusting the Keyboard Touch

### (Key Touch)

You can adjust the way in which the keyboard responds to your playing. **page 19**

### To turn key touch on

Press the [Key Touch] button so it's lit.

### To adjust the key touch

While holding down the [Key Touch] button, press the [-] [+] buttons.

## Transposing Your Performance

### (Transpose)

Transposes the keyboard and/or song. **page 21**

### To turn transpose on

Press the [Transpose] button so it's lit.

### To adjust the amount of transposition

While holding down the [Transpose] button, press the [-] [+] buttons.

## Retaining the settings even after power-off (memory backup)

The LX-15 allows you to adjust numerous settings, but these settings will return to their default values as soon as you turn off the power.

However, by using the Memory Backup feature, you can have the changes you've made in settings be retained. **page 40**

1. While holding down the [Key Touch] button, press the [Transpose] button.

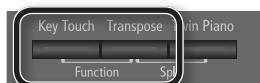

2. Use the [◀] [▶] (Slow/Fast) buttons to select "Memory Backup."
3. Press the [Song] button.
4. Use the [+] button to select "OK."
5. Press the [Song] button.



## Tone Buttons

### To select a single tone

page 14

Press one of the tone buttons, and then use the [-] [+] buttons.

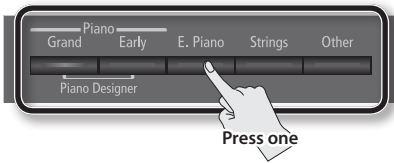

### To layer two tones (dual play)

page 15

Press two tone buttons.



<b>Tone 1</b>	Press the [-] [+] buttons.
<b>Tone 2</b>	Hold down the right-most of the lit tone button, and then use the [-] [+] buttons.

## Dividing the Keyboard for Two-person Performance (Twin Piano)

This function divides the keyboard into left and right, allowing two people to play the same range of pitches.

### To turn twin piano on

page 20

Press the [Twin Piano] button.

### To change how the sounds are heard

While holding down the [Twin Piano] button, press the [-] [+] buttons.

<b>Pair</b>	The sound of the right-hand keyboard zone will be heard more loudly from the right speaker than from the left speaker. The sound of the left-hand keyboard zone will be heard more loudly from the left speaker than from the right speaker.
<b>Individual</b>	The sound of the right-hand keyboard zone will be heard only from the right speaker. The sound of the left-hand keyboard zone will be heard only from the left speaker.

## Playing Different Tones with the Right and Left Hands (Split Play)

This function divides the keyboard into left and right zones, allowing you to play a different tone in each zone.

### To turn split on

page 16

While holding down the [Transpose] button, press the [Twin Piano] button.



### To change the tones

<b>Right-hand Tone</b>	1. Press a tone button. 2. Press the [-] [+] buttons.
<b>Left-hand Tone</b>	1. While holding down the [Transpose] button and [Twin Piano] button, press a tone button. 2. While holding down the [Transpose] button and [Twin Piano] button, use the [-] [+] buttons.

### Changing the keyboard's split point

While holding down the [Transpose] button and [Twin Piano] button, play the key that you want to specify as the split point.

## Customizing Your Piano Sound (Piano Designer)

You can adjust various elements of a grand piano's sound to create your own personalized piano.

page 38

1. While holding down the Piano [Grand] button, press the Piano [Early] button.
2. Use the [◀] [▶] (Slow/Fast) buttons to select the item that you want to adjust.
3. Use the [-] [+] buttons to adjust the value.





## Using the Metronome

Here's how to sound the metronome.

### To turn the metronome on

Press the [Metronome] button so it's lit.

### To adjust the metronome's volume

While holding down the [Metronome] button, use the [-] [+] buttons.

page 22

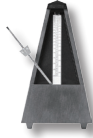

## Changing the Tempo or Time Signature

You can adjust the tempo of the metronome or song.

page 22

### To change the tempo

Use the [◀] [▶] (Slow/Fast) buttons.

### To change the time signature

While holding down the [Metronome] button, use the [◀] [▶] (Slow/Fast) buttons.



## Display

The display shows information such as the tone name, song title, tempo, and time signature.

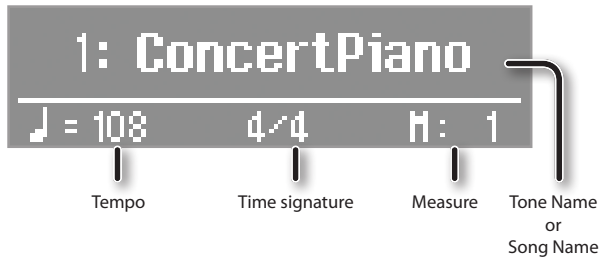

## Selecting Variation Tones/Adjusting the Settings

You can select tone variations or songs, and adjust various settings.

- Holding down the [-] [+] buttons will make the value change continuously.
- To rapidly increase the value, hold down the [+] button and press the [-] button.
- To rapidly decrease the value, hold down the [-] button and press the [+] button.
- To return the value to its default setting, press the [-] and [+] buttons simultaneously.

## Selecting a Song

First, you need to access the song screen; this is where you can select songs.

page 24

### To select a song

1. Press the [Song] button to access the song screen.

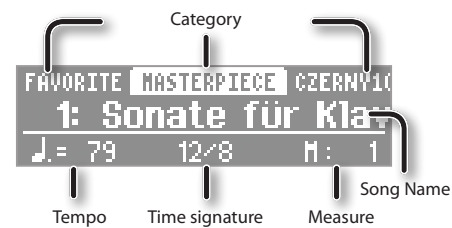

2. Use the [-] [+] buttons to select a song.

### To select a song that's saved on a USB flash drive

1. Press the [Song] button to access the song screen.
2. While holding down the [Song] button, use the [-] [+] buttons to select "USB."

USB flash drive



3. Use the [-] [+] buttons to select a song.

### Selecting the Parts that will Play

Here's how to select the parts that will play.

page 26

To select the right-hand part	Press the [Right] button so it's lit.
To select the left-hand part	Press the [Left] button so it's lit.
To select the other parts	Press the [Accomp] button so it's lit.

#### To adjust the playback volume of a part

Hold down the button of the part whose volume you want to adjust, and use the [-] [+] buttons.

### Repeatedly Practicing a Portion of a Song (AB Repeat)

Here's how you can make a specific portion of a song play back repeatedly.

page 27

1. Press the [▶/■] (Play/Stop) button to play back the song.
2. At the beginning of the portion to be repeated, press the [AB Repeat] button.
3. At the end of the portion to be repeated, press the [AB Repeat] button once again.

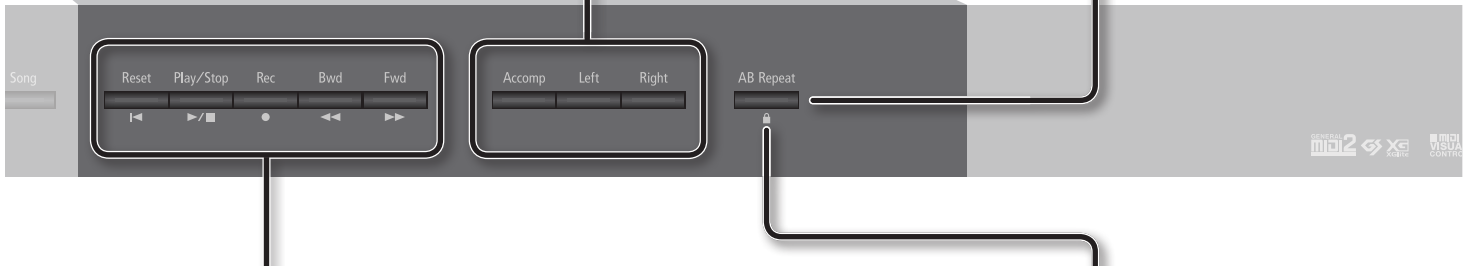

### Recording/Playback

Here's how to play back or record a song.

page 24

page 28

Return to the beginning of the song	Press the [◀] (Reset) button.
Play/Stop	Press the [▶/■] (Play/Stop) button.
Enter recording-standby mode	While stopped, press the [●] (Rec) button.
Record	While in recording-standby mode, press the [▶/■] (Play/Stop) button.
Rewind	Press the [◀◀] (Bwd) button.
Fast-forward	Press the [▶▶] (Fwd) button.

#### To play all songs (all song play)

page 25

While holding down the [Song] button, press the [▶/■] (Play/Stop) button.

#### To make a new recording

page 28

1. Select the tone that you want to play.
2. Press the [●] (Rec) button.
3. Press the [▶/■] (Play/Stop) button to start recording.
4. Press the [▶/■] (Play/Stop) button to stop recording.

### Disabling the Buttons (Panel Lock)

Hold down the [AB Repeat] button for a while.

page 43

#### To cancel panel lock

Hold down the [AB Repeat] button once again for several seconds.

#### To overdub

page 32

1. Select the tone to be played.
2. Select the song to be dubbed.
3. Press the [●] (Rec) button.
4. Press the [+] button.
5. Press the button of the part that you want to record, making it blink.
6. Press the [▶/■] (Play/Stop) button to start recording.
7. Press the [▶/■] (Play/Stop) button to stop recording.

# Panel Descriptions

## [Power] Switch

This turns the power on/off.

page 13

\* **With the factory settings, the LX-15's power will automatically be switched off 30 minutes after you stop playing or operating the unit.**

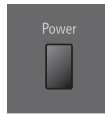

If the unit's power has been turned off automatically, you can use the [Power] switch to turn the unit back on again.

If you don't want the power to turn off automatically, change the "Auto Off" setting to "Off" as described on "Making the Power Automatically Turn Off After a Time (Auto Off)" (p. 40).

\* When turning the power on again, you must allow at least five seconds after power-off before you once again turn the power on. If you fail to allow enough time, the Auto Off function might not be reset, preventing the power from turning on correctly.

## Top Lid

By opening or closing the lid you can change the clarity of the sound.

page 12

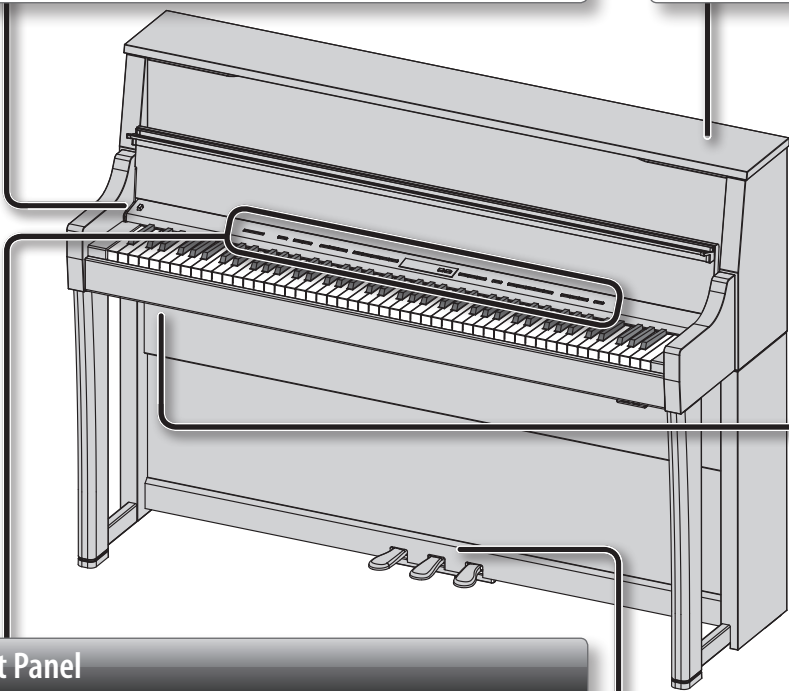
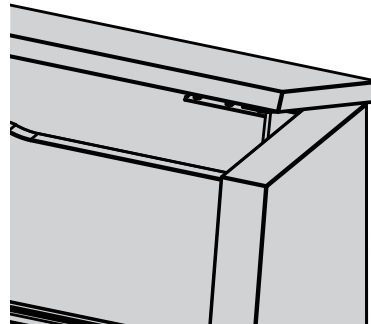

## Headphone Hook

Whenever you are not using the headphones, you can hang them on the headphone hook.



\* Don't hang anything other than headphones on this hook, and don't apply excessive force to it. Doing so may damage the headphone hook.

## Front Panel

These buttons and sliders are used to operate the LX-15.

"Operation Guide" page 6-9

## Pedals

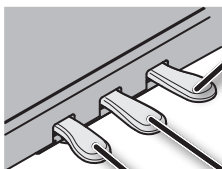

### Damper Pedal

Use this pedal to sustain the sound. While this pedal is held down, notes will be sustained for an extended time even if you release your fingers from the keyboard.

With the damper pedal on an acoustic piano, when you step on the pedal it will at first offer only a slight amount of resistance, but as you press down further it will start to feel much heavier. On the LX-15, this change in the feeling of resistance is simulated.

On an acoustic piano, when you step on the damper pedal, you'll first hear the sound of the dampers releasing the strings. Then, you should also be able to hear the sound of strings adjacent to the ones for the notes actually played resonate sympathetically, resulting in a rich, resounding tone.

Additionally, when using half-pedaling techniques, the core of the sound disappears rapidly while a rich, spacious resonance remains, producing a unique form of reverberation. On the LX-15, the unique, lingering tones produced by the half-pedaling technique are reproduced in addition to released-string sounds (Damper Noise) and resonating sounds (Damper Resonance).

### Sostenuto Pedal

The notes you are pressing when this pedal is depressed will be sustained.

### Soft Pedal

This pedal is used to make the sound softer.

Playing with the soft pedal depressed produces a sound that is not as strong as when otherwise played with the equivalent strength. This is the same function as the left pedal of an acoustic piano.

The softness of the tone can be varied subtly by the depth to which you press the pedal.



### USB Memory Connector

If a USB flash drive is connected, you can use it to save or play back songs.

page 24    page 37

You can do the following things using a USB flash drive.

- WAVE files or MIDI files (SMF) data copied from your computer can be played back by the LX-15.
- You can make audio recordings of your performances on the LX-15.
- The audio recordings of songs that you've made can be played on your computer, or burned to a CD.
- \* Carefully insert the USB flash drives all the way in-until it is firmly in place.
- \* Use a USB flash drive sold by Roland. We cannot guarantee operation if any other USB flash drive is used.



### USB Connector

If you use a commercially available USB cable to connect the LX-15's USB connector to your computer's USB connector, you'll be able to do the following things.

- SMF data played back by MIDI-compatible software can be sounded by the LX-15.
- MIDI data can be transferred between the LX-15 and your sequencer software, opening up a wide range of possibilities for music production and editing.

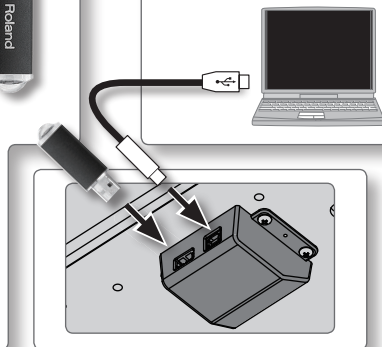

### Pedal Connector

Connect the pedal cord of the dedicated stand to this connector.

page 59

### AC In (AC Inlet)

Connect the included power cord here.

page 59

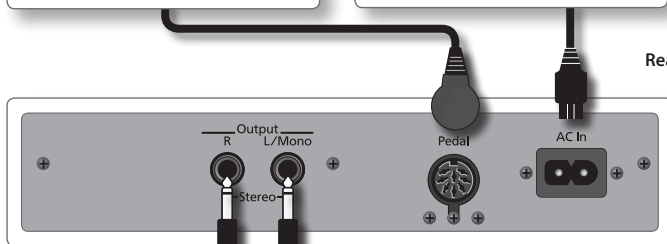

Rear side

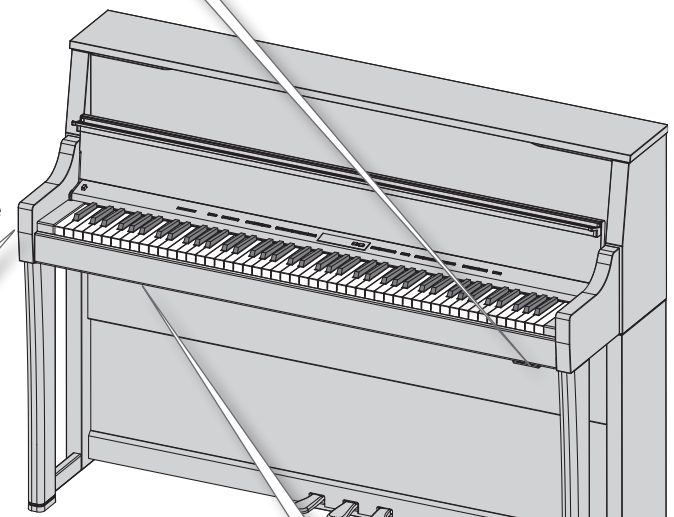

### Output Jacks

If you connect these jacks to amplified speakers, the sound of LX-15 will be heard through them.



### Phones Jacks

Here you can connect headphones. The LX-15 has two headphone jacks, two people can also use headphones simultaneously.



**Don't forget to remove your headphone adaptor plug!**

If you leave a headphone adaptor plug inserted in the headphone jack, no sound will be heard from the piano. If you don't hear sound from the piano, check the headphone jacks.



### Input Jacks

If a digital audio player or other audio playback device is connected here, you'll be able to listen to its playback through the LX-15. Use the controls of your audio playback device to adjust the volume.



### MIDI Connectors

You can connect these to external MIDI devices.

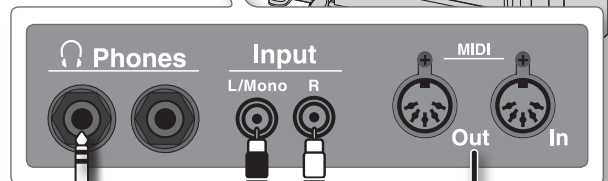

\* To prevent malfunction and/or damage to speakers or other devices, always turn down the volume, and turn off the power on all devices before making any connections.

\* When connection cables with resistors are used, the volume level of equipment connected to the Input jacks may be low. If this happens, use connection cables that do not contain resistors.

## Opening/Closing the Lid

**NOTE**

To open the lid, use both hands to lift it lightly. The lid of the LX-15 is designed to close softly even if you remove your hands from it. However, it will close quite abruptly if it has been opened only slightly. Be careful not to pinch your fingers in the gap.

**1.** To open the lid, use both hands to lift it.

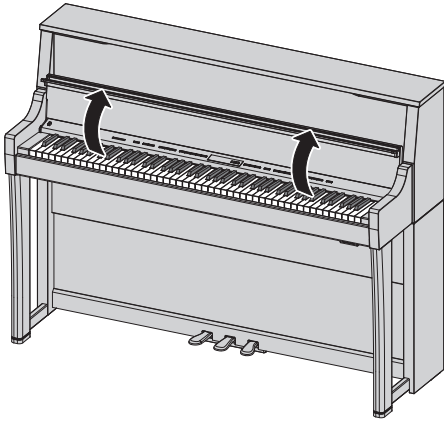

**2.** To close the lid, use both hands to gently lower it.

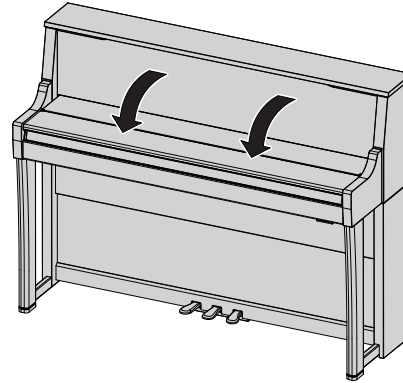

**NOTE**

If you need to move the piano, make sure the lid is closed first to prevent accidents.

## Opening/Closing the Top Lid

Opening the lid will make the sound more sharply defined; closing the lid produces a more mellow sound.

**NOTE**

- The top lid must be opened or closed by an adult.
- Do not force the top lid backward; doing so will damage it.
- Be careful not to pinch your fingers in the gap.

### Opening the Top Lid

**1.** Lift up the top lid with both hands.

### Closing the Top Lid

- 1.** Lift up the top lid with both hands.
- 2.** Gently lower the top lid.

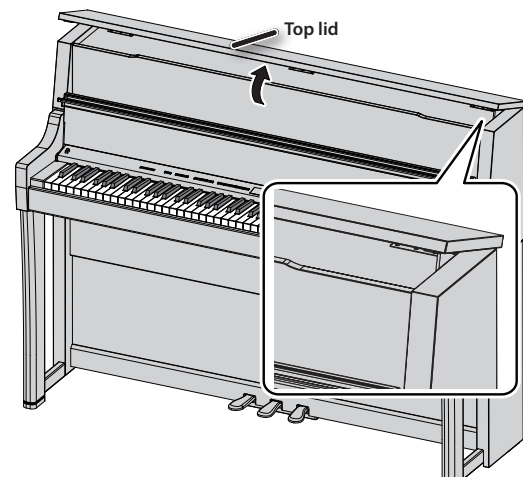

## Using the music rest

You can place music books or sheet music on the top edge of the opened lid.

### Tips for placing music

- Insert the sheet music into the groove on the top edge of the lid.
- Crease sheet music so that it will stay open.  
If this does not work, use paper clips to secure it.
- If the sheet music is thin, attach it to a clipboard before placing it on the music Rest.

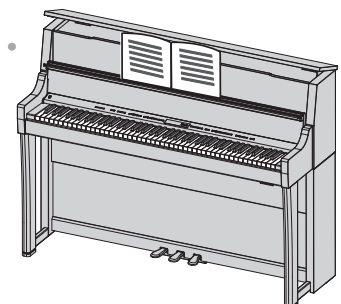

## Turning the Power On/Off

### NOTE

- Once the connections have been completed (p. 11), turn on power to your various devices in the order specified. By turning on devices in the wrong order, you risk causing malfunction and/or damage to speakers and other devices.
- Before switching the power on/off, always be sure to turn the volume down. Even with the volume turned down, you might hear some sound when switching the power on/off. However, this is normal and does not indicate a malfunction.

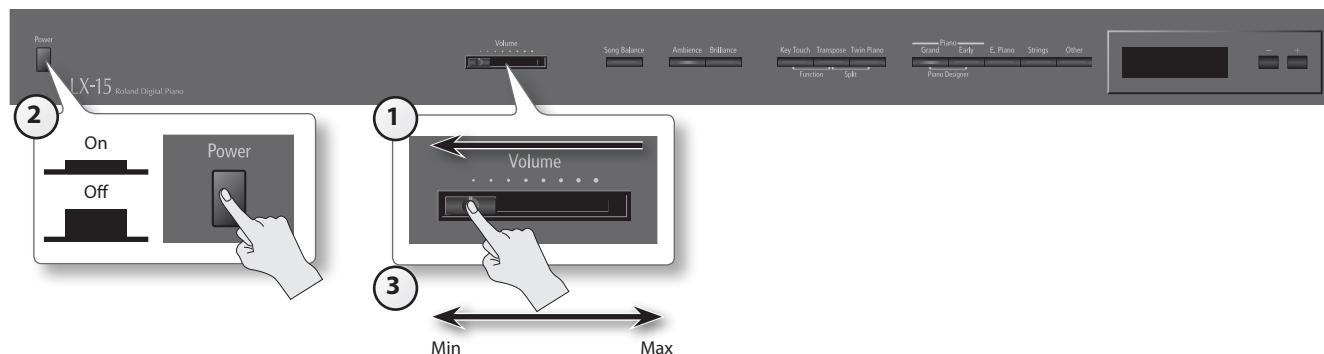

### Turning the power on

**1. Move the [Volume] slider all the way to the left to minimize the volume.**

**2. Press the [Power] switch.**

After a brief interval, you'll be able to produce sounds by playing the keyboard.

\* This unit is equipped with a protection circuit. A brief interval (a few seconds) after power up is required before the unit will operate normally.

**3. Use the [Volume] slider to adjust the volume.**

Adjust the volume while playing something on the keyboard, so you can hear how it sounds.

The volume increases when you slide it to the right, and decreases when you slide it to the left.

### MEMO

The LX-15 is designed so that nuances in the dynamics of your playing will be clearly heard even at low volume, and that the sound will remain clear even at high volume.

### Turning the power off

**1. Move the [Volume] slider all the way to the left to minimize the volume.**

**2. Press the [Power] switch.**

The power is turned off.

\* If you need to turn off the power completely, first turn off the POWER switch, then unplug the power cord from the power outlet. Refer to "Power Supply" (p. 56).

### If you don't want the power to turn off automatically, change the "Auto Off" setting to "Off"!

**With the factory settings, the LX-15's power will automatically be switched off 30 minutes after you stop playing or operating the unit.**

If the unit's power has been turned off automatically, you can use the [Power] switch to turn the unit back on again.

If you don't want the power to turn off automatically, change the "Auto Off" setting to "Off" as described on "Making the Power Automatically Turn Off After a Time (Auto Off)" (p. 40).

### NOTE

- When turning the power on again, you must allow at least five seconds after power-off before you once again turn the power on. If you fail to allow enough time, the Auto Off function might not be reset, preventing the power from turning on correctly.
- The settings will be initialized after the power has been turned off. If you want to still be retained the next time you turn on the power, you should refer to "Having Your Settings Be Retained after the Power Is Turned Off (Memory Backup)" (p. 40) and save your settings.

## Performing with Various Sounds

In addition to piano sounds, the LX-15 lets you enjoy performing with many other sounds (347 types).

These sounds are called “Tones.” The Tones are divided into five groups, each of which is assigned to a different Tone button.

## Switching Tones

Let’s start by performing with a piano tone.

When you turn on the power, the “ConcertPiano” tone is selected.

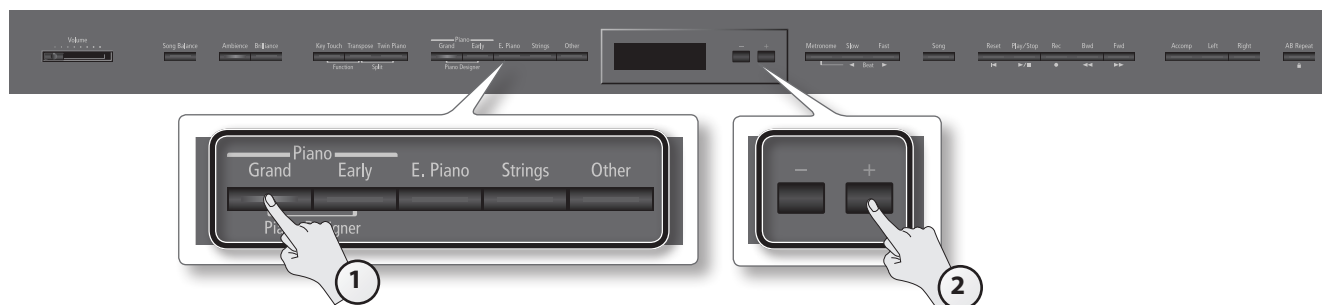

### 1. Press a tone button to select the tone group.

The currently selected tone number and tone name are displayed.



## Tone groups

Tone button	Description
Piano [Grand] button	Selects grand piano sounds.
Piano [Early] button	Selects sounds of early historical pianos.
[E. Piano] button	Selects various electric piano sounds used in pop or rock.
[Strings] button	Selects the sounds of string instruments such as violins, as well as other instruments used in orchestras.
[Other] button	Selects a variety of sounds such as organ, bass, or accompaniment sounds. * If you select tone numbers 43–51, you’ll be able to use the keyboard to play the sounds of a drum set. * If you’ve selected an organ sound that provides a rotary effect (*1), such as a Combo Jz. Org or a Ballad Organ, pressing the [Other] button will switch the speed of the rotary effect.

For details on the tones, refer to “Tone List” (p. 52).

\*1 Rotary effect:

Rotary is an effect which simulates the sound of rotating speakers. There is a choice of two settings: Fast and Slow.

### 2. Use the [-] [+] buttons to select a variation within the tone group.

\* If you’ve selected a drum set tone or an SFX set tone, some notes of the keyboard will not produce sound.

## Auditioning tones (tone demo)

### 1. While holding down a tone button, press the [▶/■] (Play/Stop) button.

A tone demo will play.

### 2. To stop the tone demo, press the [Song] button.

## If you are using the VIMA TUNES

You can connect a USB CD drive (sold separately) to the LX-15 (p. 47), and play back separately sold CD-ROMs created for the VIMA.

Songs on VIMA CD-ROM (VIMA TUNES) are programmed with “recommended tones” suitable for each song.

When you select a song from a VIMA CD-ROM (VIMA TUNES), recommended tones will be assigned to the LX-15’s [E. Piano], [Strings], and [Other] tone buttons, and these three tone buttons will blink. When you press a flashing Tone button, the recommended tone is then selected, enabling you to perform the selected song using a tone matched to that song as it plays back.

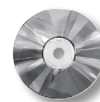

## Performing with Two Layered Tones (Dual Play)

You can play two tones simultaneously from each note of the keyboard. This feature is called “Dual Play.” As an example, here’s how to layer piano and strings tones.

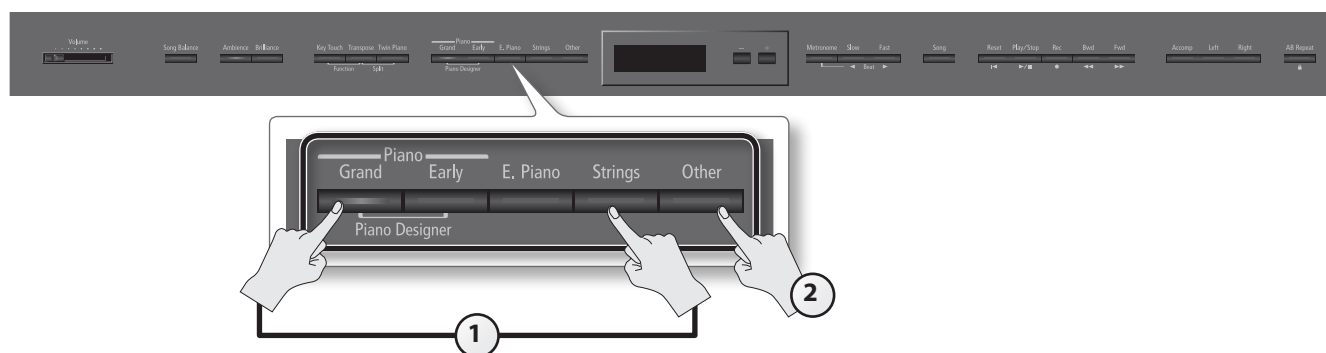

### 1. While holding down the Piano [Grand] button, press the [Strings] button.

Both buttons will light.

When you play the keyboard, you’ll hear both the piano and the strings tones.



### Selecting tones for dual play

Tone name	Corresponding button	How to select tones
Tone 1	Left tone button	Press the [-] [+] buttons.
Tone 2	Right tone button	While holding down the tone button for Tone 2 (the right-most of the lit Tone buttons), and press the [-] [+] buttons.

### 2. To exit Dual Play, press one of the tone buttons.

- \* Dual play is not available if Split Play (p. 16) or Twin Piano (p. 20) are turned on.
- \* For some combinations of sounds, the effect is not applied to tone 2, and this may affect how the tone sounds.
- \* It’s not possible to layer Piano [Grand] and Piano [Early] tones together.

#### Advanced techniques

- Changing the pitch of tone 2 in steps of an octave: “Octave Shift” (p. 45)
- Specifying the part(s) affected by the damper pedal: “Damper Pedal Part” (p. 45)
- Adjusting the volume balance of the two tones: “Dual Balance” (p. 44)

#### What are effects?

In addition to reverb, the LX-15 provides a wide variety of other “effects” that can modify the sound in various ways. The rotary effect is one of these effects.

## Playing Different Tones with the Right and Left Hands (Split Play)

You can play different tones in the left and right sides of the keyboard, divided at a certain key. This feature is called “Split Play,” and the key at which the keyboard is divided is called the “Split Point.”

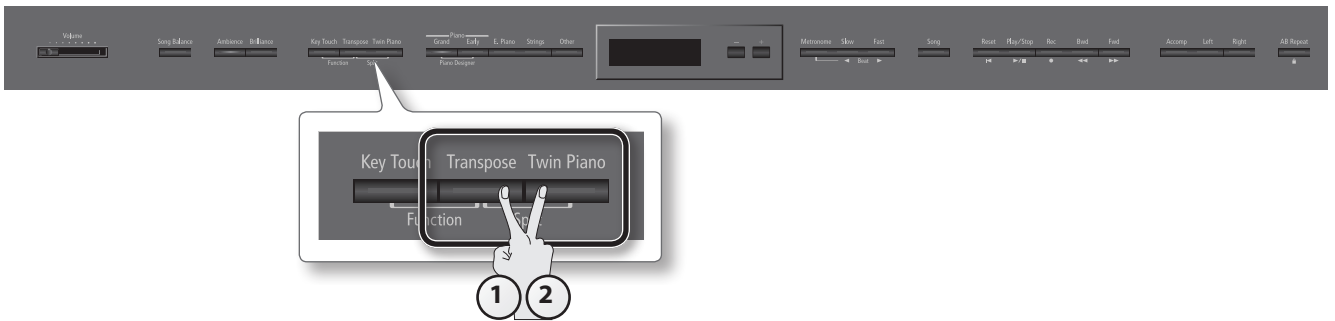

1. While holding down the [Transpose] button, press the [Twin Piano] button. The Split screen will appear.



When Split is turned on, the keyboard settings will be as follows.

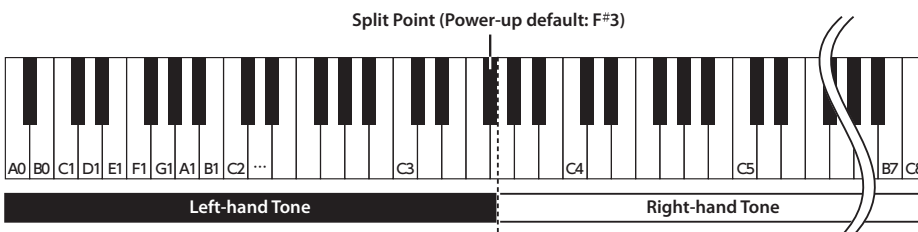

2. To exit Split Play, hold down the [Transpose] button and press the [Twin Piano] button once again.

\* Depending on which tones are being used together, the tones might sound different because no effect is applied to the left-hand zone.

### Advanced technique

Specifying the part(s) affected by the damper pedal: “Damper Pedal Part” (p. 45)

## Changing the right-hand tone

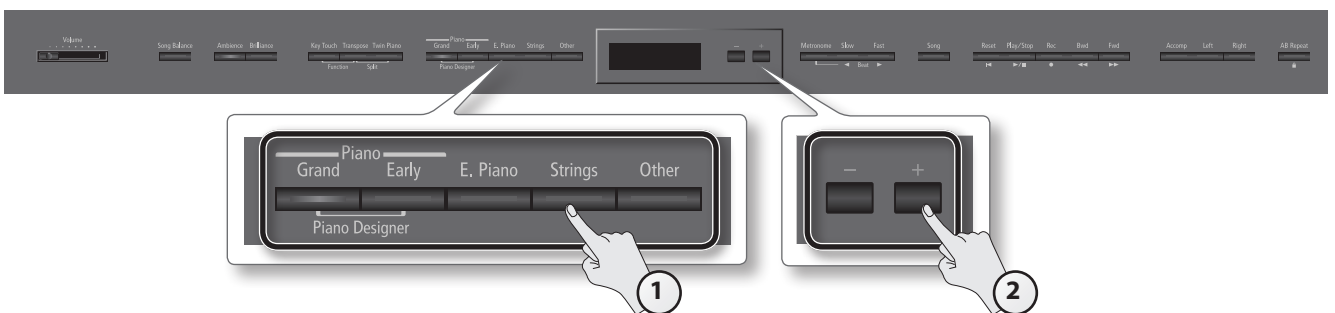

1. Press a tone button. The number and name of tone currently selected for the right-hand zone are shown.
2. Press the [-] [+] buttons. A different tone is selected.

## Changing the left-hand tone

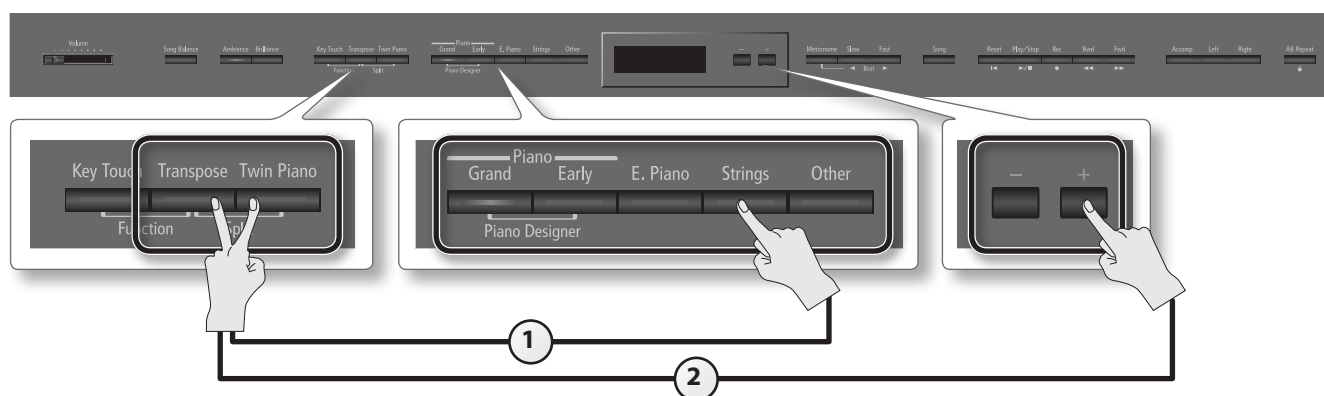

1. While holding down the [Transpose] button and [Twin Piano] button, press a tone button.  
The number and name of the tone currently selected for the left-hand zone are shown.
2. While holding down the [Transpose] button and [Twin Piano] button, press the [-] [+] buttons.  
A different tone is selected.

### Advanced technique

Changing the pitch of the left-hand tone in steps of an octave: "Octave Shift" (p. 45)

## Changing the keyboard's split point

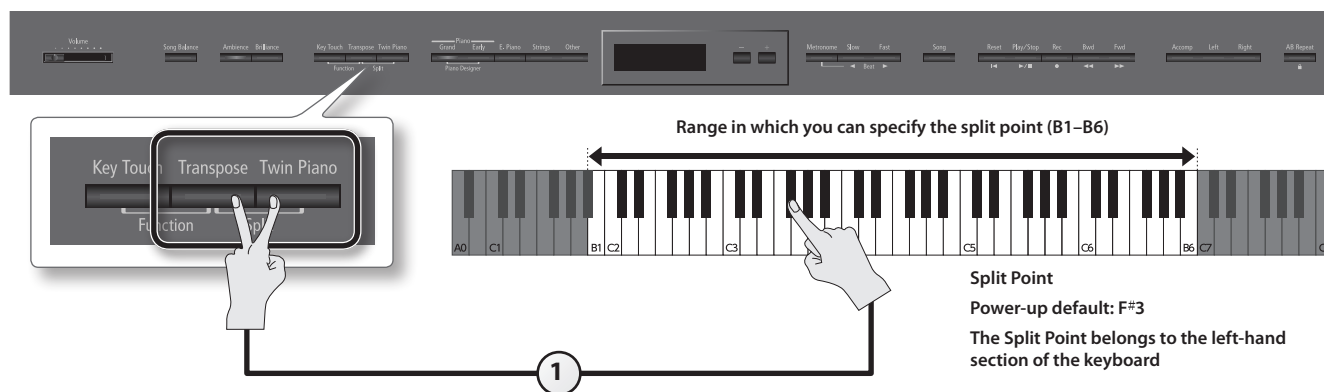

1. While holding down the [Transpose] button and [Twin Piano] button, press the key that you want to assign as the split point.  
The key you pressed becomes the new split point, and that key will be shown in the display.

Screen	Value
Split Point F#3	B1-B6 (default: F#3)

### Saving your settings

The LX-15's settings will revert to the default values when you turn off the power, but you can save them as described in "Retaining the Settings Even After Power-off (Memory Backup)" (p. 40).

## Adjusting the Sound to Your Taste

The LX-15 lets you add reverberation or modify the brightness of the sound.

### Changing the clarity of the sound (opening/closing the lid)

Opening the lid will make the sound more sharply defined; closing the lid produces a more mellow sound (p. 12).

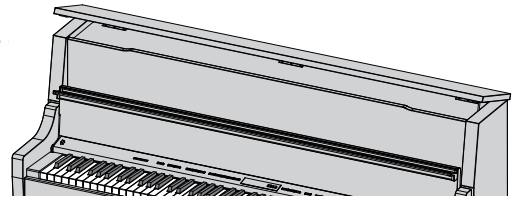

### Adding Reverberation to the Sound (Ambience)

You can add a pleasant reverberation to the sounds of the LX-15, producing the impression that you are performing in a concert hall. This effect is called "Ambience."

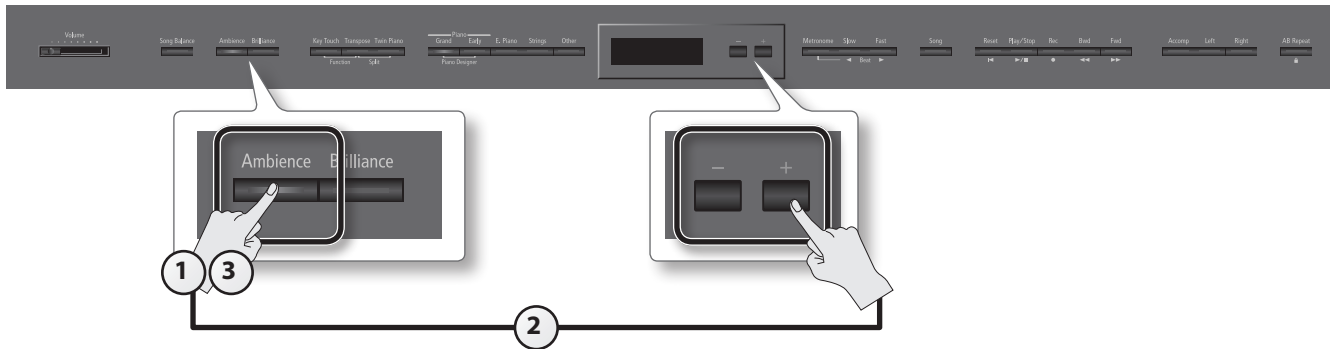

- 1. Press the [Ambience] button.**  
The [Ambience] button will light.
- 2. While holding down the [Ambience] button, press the [-] [+] buttons.**  
The display will indicate the depth of the ambience effect values.

#### Saving your settings

The LX-15's settings will revert to the default values when you turn off the power, but you can save them as described in "Retaining the Settings Even After Power-off (Memory Backup)" (p. 40).

Screen	Value	Explanation
	1-10 (default: 5)	Higher values apply deeper ambience.

- 3. To turn off the ambience effect, press the [Ambience] button once again.**  
The [Ambience] button will go out.

- \* It's not possible to specify the depth of ambience individually for each tone. The effect will be applied in the same way to each tone.
- \* The amount of ambience for the song will not change.



## Adjusting the Brightness of the Sound (Brilliance)

You can adjust the brightness of the sounds played on the keyboard or played back by a song.

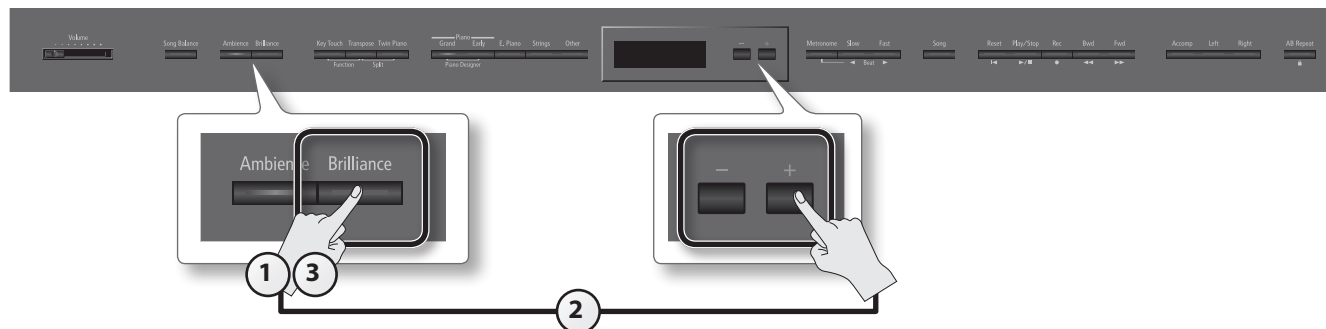

- 1. Press the [Brilliance] button.**  
The [Brilliance] button will light.
- 2. While holding down the [Brilliance] button, press the [-] [+] buttons.**  
The display will indicate the depth of the brilliance effect values.

### Saving your settings

The LX-15's settings will revert to the default values when you turn off the power, but you can save them as described in "Retaining the Settings Even After Power-off (Memory Backup)" (p. 40).

Screen	Value	Explanation
	-10-0-10 (default: 5)	Positive (+) values make the sound brighter; negative (-) values make the sound more mellow.

- 3. To turn off the brilliance effect, press the [Brilliance] button once again.**  
The [Brilliance] button will go out.

## Adjusting the Keyboard Response (Key Touch)

The way in which the keyboard responds to your playing strength can be adjusted to your personal taste.

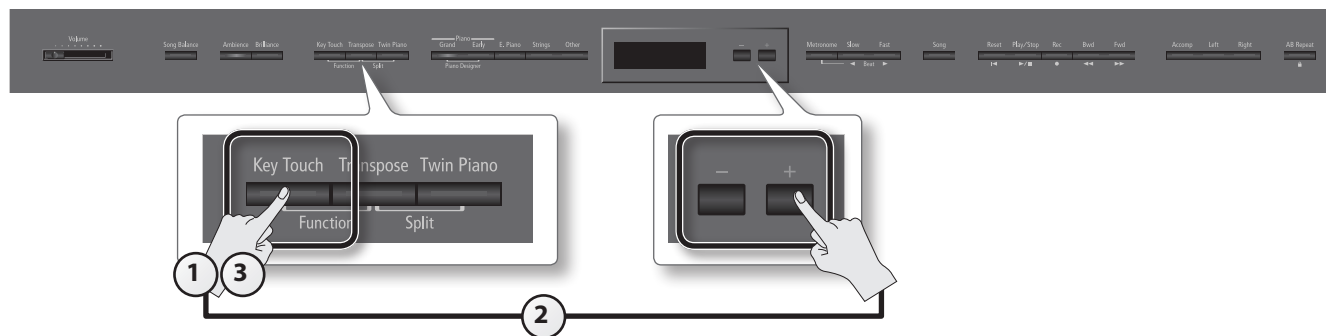

- 1. Press the [Key Touch] button.**  
The [Key Touch] button will light.
- 2. While holding down the [Key Touch] button, press the [-] [+] buttons.**  
The display will indicate the key touch setting.

### Saving your settings

The LX-15's settings will revert to the default values when you turn off the power, but you can save them as described in "Retaining the Settings Even After Power-off (Memory Backup)" (p. 40).

Screen	Value	Explanation
	Fix, 1-100 (default: 70)	Higher values will make the keyboard feel heavier. If you've specified "Fix", notes will sound at the same volume regardless of how strongly you play the keyboard.

- 3. To cancel key touch, press the [Key Touch] button once again.**  
The [Key Touch] button will go out.

## Dividing the Keyboard for Two-person Performance (Twin Piano)

You can divide the keyboard into left and right zones so that two people can play the same range of pitches, just as though there were two pianos. This function is called “Twin Piano.”

For example, you could use Twin Piano to allow a student to play along with their teacher.

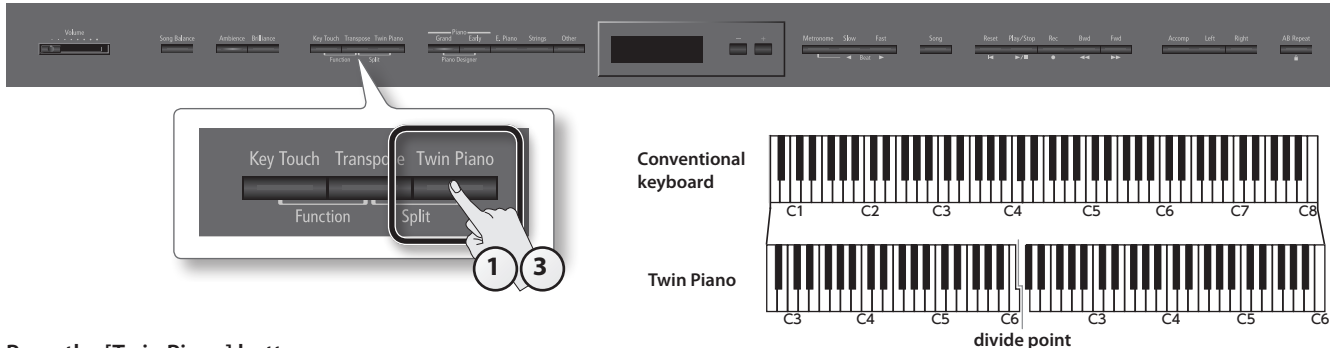

### 1. Press the [Twin Piano] button.

The [Twin Piano] button will light, and the “ConcertPiano” tone will be selected.

When you turn Twin Piano on, the keyboard and pedal settings will be as shown in the illustration.

**NOTE**

If Twin Piano is on, damper resonance will not be applied; this may cause the piano to sound different.

### 2. Select the tone to be played (p. 14).

The left and right sections will have the same tone.

### 3. To cancel Twin Piano, press the [Twin Piano] button once again.

The [Twin Piano] button will go out.

## Changing the way in which the sound is heard (twin piano mode)

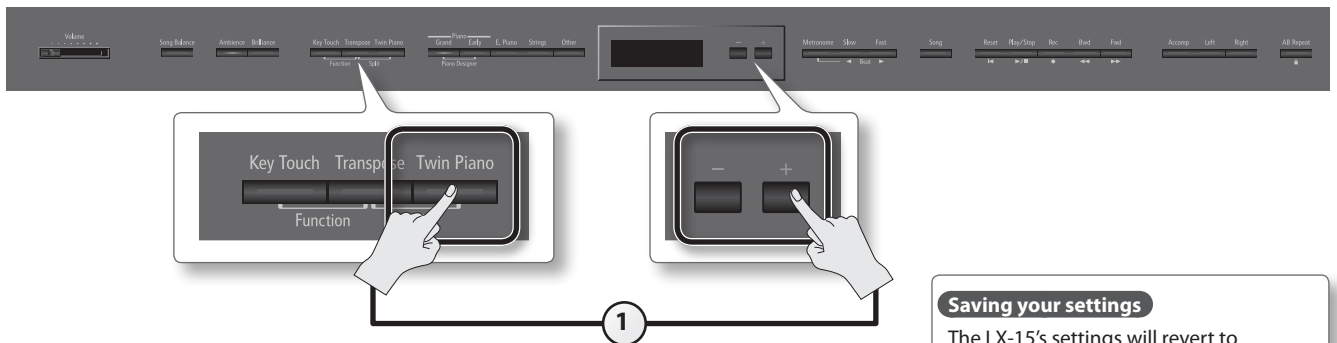

### 1. While holding down the [Twin Piano] button, press the [-] [+] buttons.

The display will indicate Twin Piano mode.

**Saving your settings**

The LX-15's settings will revert to the default values when you turn off the power, but you can save them as described in “Retaining the Settings Even After Power-off (Memory Backup)” (p. 40).

Screen	Value	Explanation
	Pair	The sound of the right-hand keyboard zone will be heard more loudly from the right speaker than from the left speaker. The sound of the left-hand keyboard zone will be heard more loudly from the left speaker than from the right speaker. When using headphones, you'll be able to hear the other person's playing.
<b>Twin Piano Mode Individual</b>	Individual (default)	The sound of the right-hand keyboard zone will be heard only from the right speaker. The sound of the left-hand keyboard zone will be heard only from the left speaker. When using headphones, you won't be able to hear the other person's playing. * Ambience will turn off. * For some tones, the sound might not be divided to left and right. * If using headphones, connect them to the left Phones jack if playing the left keyboard zone; connect them to the right Phones jack if playing the right keyboard zone. * If you record while this is set to Individual, the playback might not be the same as what you heard during recording.

# Shifting the Pitch (Transpose)

“Transpose” means to shift the pitches of songs and the keyboard.

The Transpose function makes it easy to do the following.

- You can use unchanged fingering to accompany a singer who is singing in a key different than the original music.
- A song written in a difficult key with numerous sharps (#) or flats (b) can be performed in a key that’s easier for you to play.
- Notation of a transposing instrument such as trumpet or sax can be played as written, while hearing the transposed pitches.

For example if the song is written in E major but you want to play it using the fingering of the key of C major, you would set Transpose to “4.”

If you play C E G → It will sound E G# B

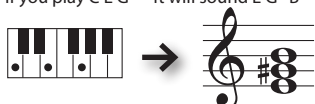

**MEMO**

With the factory settings, both the song and the keyboard will be transposed. If you want to transpose only the keyboard or only the song, make the appropriate setting as described in “Specifying What the Transpose will Affect (Transpose Mode)” (p. 45).

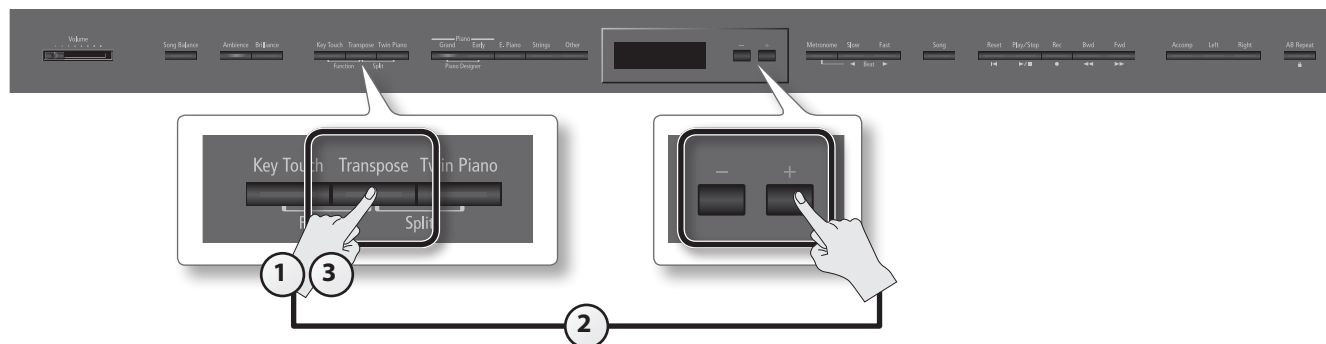

- 1. Press the [Transpose] button.**  
The [Transpose] button will light.
- 2. While holding down the [Transpose] button, press the [-] [+] buttons.**  
The display will indicate the amount of transposition.

Screen	Value	Explanation
	-6-0-5 (semitone units) (default: 1)	Positive (+) values raise the pitch in semitone steps, and negative (-) values lower the pitch in semitone steps.

**MEMO**

You can also specify this value by holding down the [Transpose] button and playing the note that is the tonic of the key to which you want to transpose.

\* If you select a different song, the transposition setting will be canceled.

- 3. To cancel the transposition, press the [Transpose] button once again.**  
The [Transpose] button will go out.

## Practicing with the Metronome

You can sound the metronome while you practice.

While the song plays, the metronome will sound at the tempo and time signature of the song.

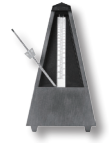

### 1. Press the [Metronome] button.

The [Metronome] button will blink, and the metronome will sound.

The [Metronome] button will blink red and green according to the currently selected time signature; red indicates the strong beats, and green indicates the weak beats.

### 2. To stop the metronome, press the [Metronome] button once again.

The [Metronome] button will go out.

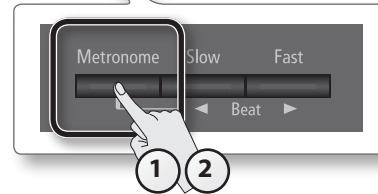

## Changing the Tempo



### 1. Press the [◀] [▶] (Slow/Fast) buttons.



Tempo

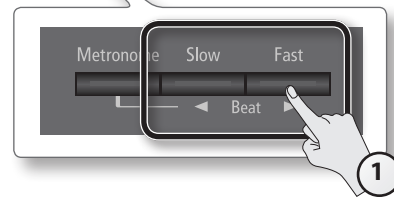

If you record your performance, it will be recorded with the tempo you specify here.

When you play back a song, the metronome's tempo will be set to the tempo of that song.

## Changing the Time Signature



### 1. While holding down the [Metronome] button, press the [◀] [▶] (Slow/Fast) buttons.



Time signature

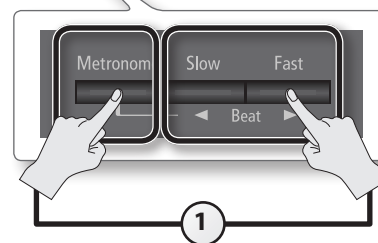

If you specify "0/4" only the weak beats will sound.

If you record your performance, it will be recorded with the time signature you specify here.

When you play back a song, the metronome's time signature will be set to the time signature of that song.

Available time signatures	2/2, 0/4, 2/4, 3/4, 4/4, 5/4, 6/4, 7/4, 3/8, 6/8, 9/8, 12/8 (default: 4/4)
---------------------------	---

\* You can't change the metronome's time signature while a song is playing.

\* If you record using 0/4, the song's time signature will be set to 4/4 when you save it.

## Adjusting the Metronome's Volume



1. While holding down the [Metronome] button, press the [-] [+] buttons.

The display will indicate the metronome's volume.

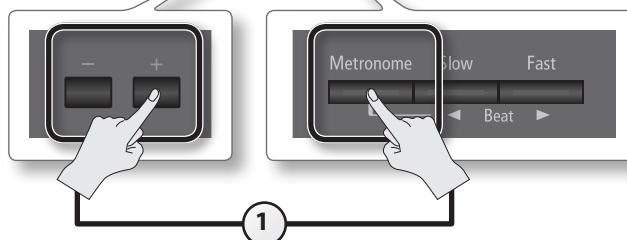

Screen	Value	Explanation
	0-10 (default: 5)	When the volume of the metronome is set to "0," the metronome won't sound, but the [Metronome] button will blink.

## Adding a Count-in to Synchronize Your Performance

A series of sounds rhythmically played to indicate the tempo before a song starts is called a "count-in."

If you sound a count-in, it will be easier for you to synchronize your own performance to the tempo of the playback.



1. Press the [Metronome] button.

The metronome will sound.

2. Press the [▶/■] (Play/Stop) button.

A two-measure count sound will be produced before the song starts playing.

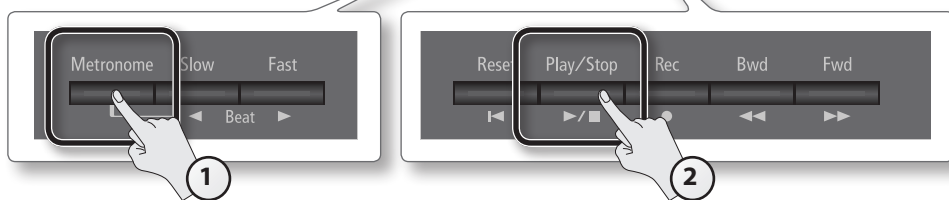

## Practicing with a Song

You can practice by playing along with a song.

## Selecting and Playing a Song

Here's how to listen to the built-in songs. The LX-15 provides 195 built-in piano songs. You can also play back songs stored on a separately sold USB flash drive.



1. Press the [Song] button.  
The song screen will appear.
2. While holding down the [Song] button, use the [-] [+] buttons to select the category.

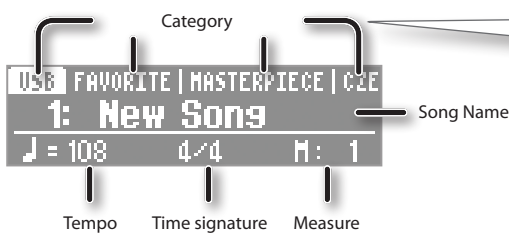
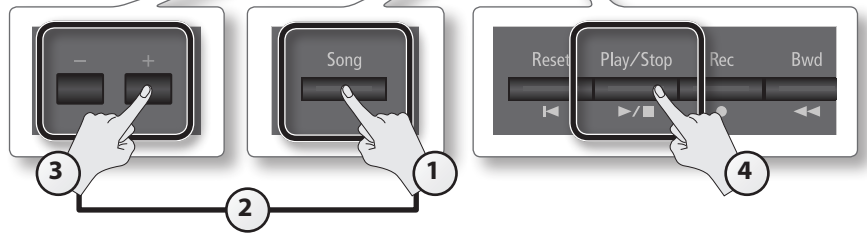

Category	Explanation
USB	Songs saved on a USB flash drive
FAVORITE	Songs saved in Favorite (internal memory)
MASTERPIECE	Piano Masterpieces
CZERNY 100	Songs built into the LX-15 Czerny
HANON	Hanon

3. Use the [-] [+] buttons to select a song.

**MEMO**

- To select a song that's inside a folder, select the folder and press the [▶/■] (Play/Stop) button.
- To exit the folder, select "(Up)" and press the [▶/■] (Play/Stop) button.
- \* If a folder contains 500 or more files and/or folders, some of the files and folders may not be displayed.

4. Press the [▶/■] (Play/Stop) button.

When the song has played to its end, playback will stop.  
To pause the playback, press the [▶/■] (Play/Stop) button once again.  
The next time you press the [▶/■] (Play/Stop) button, playback will resume from where you paused.

## Button operations

[◀] (Reset) button	Returns you to the beginning of the song.
[▶/■] (Play/Stop) button	Plays/stops the song. Starts/stops recording.
[●] (Rec) button	Enables recording.
[◀◀] (Bwd) button	Rewinds the song.
[▶▶] (Fwd) button	Fast-forwards the song.

## Song formats that can be played by the LX-15

The LX-15 can play back data in the following formats.

- SMF formats 0/1
- Roland Piano Digital format (i-format)
- Audio files: WAV format, 44.1 kHz, 16-bit linear

## Playing Songs Consecutively (All Songs Play)

You can consecutively play back the built-in songs or the songs saved in Favorite (internal memory) or on a USB (USB flash drive). This function is called "All Songs Play."

**1. While holding down the [Song] button, use the [-] [+] buttons to select the category.**

**2. While holding down the [Song] button, press the [▶/■] (Play/Stop) button.**

All Songs Play will be selected, and the [▶/■] (Play/Stop) button will blink.

\* All Song Play will be cancelled if you stop playback or turn off the power.

## Adjusting the Volume Balance of the Song and the Keyboard Performance (Song Balance)

You can adjust the balance between the song and your keyboard performance by changing the volume of the song.

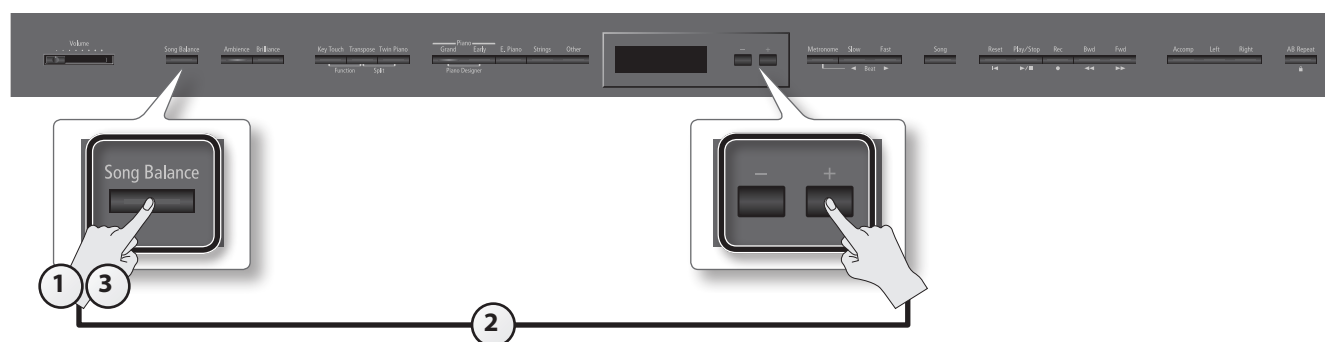

**1. Press the [Song Balance] button.**

The [Song Balance] button will light.

**2. While holding down the [Song Balance] button, press the [-] [+] buttons.**

The display will show the song balance.

Screen	Value	Explanation
	0-9 (default: 5)	The song's volume decreases the more you lower this value, and time the keyboard performance will take on more prominence. The song's volume increases the more you raise this value, and at the same time the keyboard performance will become less prominent.

**3. To cancel the Song Balance function, press the [Song Balance] button once again.**

The [Song Balance] button will go out.

## Adjusting a Song's Tempo for Easier Practicing

You can change the tempo at which a song plays back.

When you're practicing along with a song, this allows you to slow down the tempo of a difficult song in order to play it more comfortably.

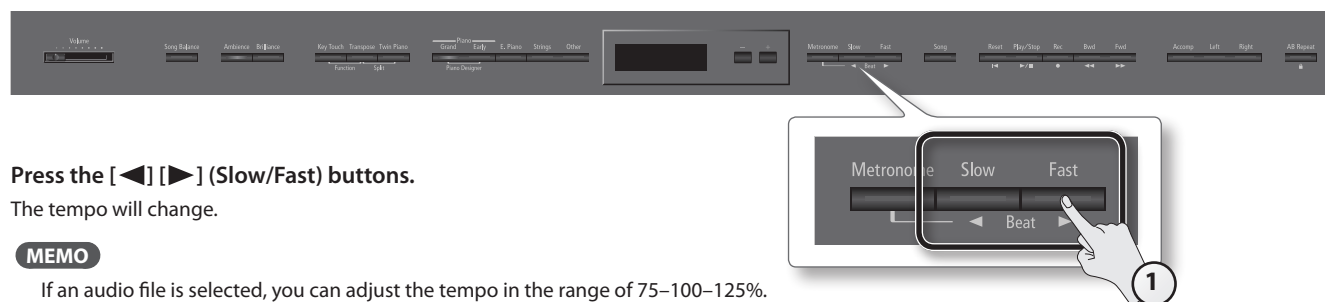

**1. Press the [◀] [▶] (Slow/Fast) buttons.**

The tempo will change.

### MEMO

If an audio file is selected, you can adjust the tempo in the range of 75-100-125%.

## Playing back at a fixed tempo (tempo mute)

With some of the internal songs, the tempo will change during the song. If desired, you can make these songs play back at a fixed, unchanging tempo.

**1. While holding down the [▶/■] (Play/Stop) button, use the [◀] [▶] (Slow/Fast) buttons to adjust the tempo.**

The tempo indication in the screen will be highlighted.

**2. To return the tempo to its original setting, press the [◀] (Slow) and [▶] (Fast) buttons simultaneously.**

## Practicing One Hand at a Time (Part Mute)

Here's how to have only the selected part play back. This allows you to practice playing the left or right-hand part of a song while listening to the other hand played automatically.



### Part

Each part is assigned to the part buttons as shown in the illustration.

### Muting

You can "mute" a specific part so that it will not be heard.

- \* If you've selected a song that does not contain an accompaniment, the [Accomp] button will not light even if you press it.

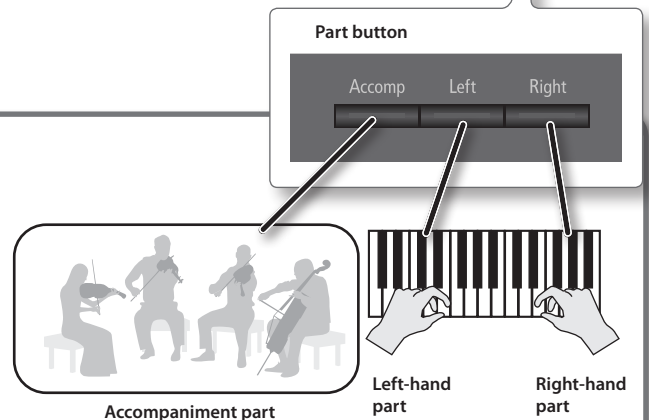

### 1. Press the part button for the part that you don't want to be played.

The light for the button you pressed will go out, and the selected part will not be heard.

#### MEMO

- If the accompaniment part is muted, playback will skip the introduction.
- The mute setting will be cancelled when you switch songs.
- Although the Part Mute function cannot be used with respect to the playback of an audio file, you can reduce the volume during playback of sounds that are localized at the center of the sound field, such as vocals or bass. See "Center Cancel" (p. 35).

### 2. To un-mute the sound, press the part button once again so it's lit.

## Using the sound of a specific part as a "guide" (mute volume)

If desired, you can specify that the sound of a part will play at a reduced volume rather than going completely silent when you press a part button and turn off its indicator.

This setting lets you play a specific part at a reduced volume and use it as a "guide" for your playing.



### 1. While holding down the part button, press the [-] [+] buttons.

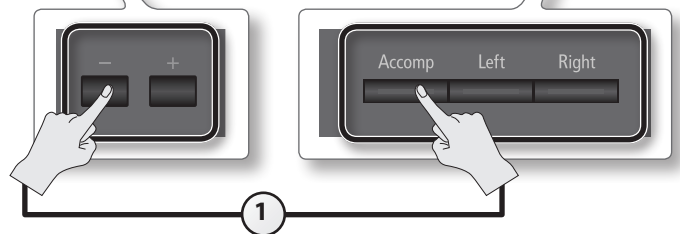

Screen	Value	Explanation
Mute Volume Accomp Min 0 Max	0-10 (default: 0)	Higher values make the sound louder.
Mute Volume Left Min 0 Max		
Mute Volume Right Min 0 Max		



## Repeatedly Practicing a Portion of a Song (AB Repeat)

Here's how you can repeatedly play back a specified portion of the song. You can use this function to repeatedly practice that portion.

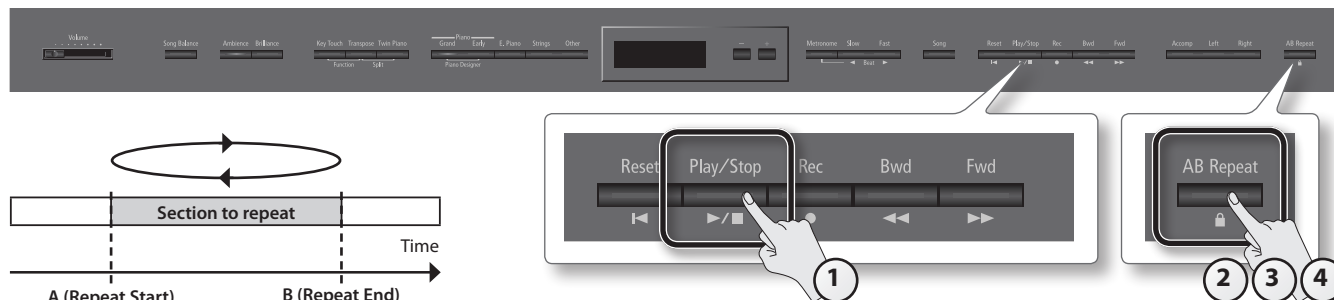

1. Press the [▶/■] (Play/Stop) button.  
The song will play back.
2. Press the [AB Repeat] button at the point where you want to start repeating (point A).
3. Press the [AB Repeat] button at the point where you want to stop repeating (point B).  
AB Repeat will turn on, and playback will begin repeating.
4. To cancel the repeat function, press the [AB Repeat] button once again.  
When you cancel AB Repeat, the repeat points you specified will be cleared.

### MEMO

- The repeat points can be specified in measures of beats for an SMF song, or in 1/100 ths of a second for audio.
- Instead of playing back the song, you can also specify the portion to repeat by using the [◀◀] [▶▶] buttons.

## Moving the portion to repeat forward or backward

When AB Repeat is on, you can move the repeated portion forward or backward.

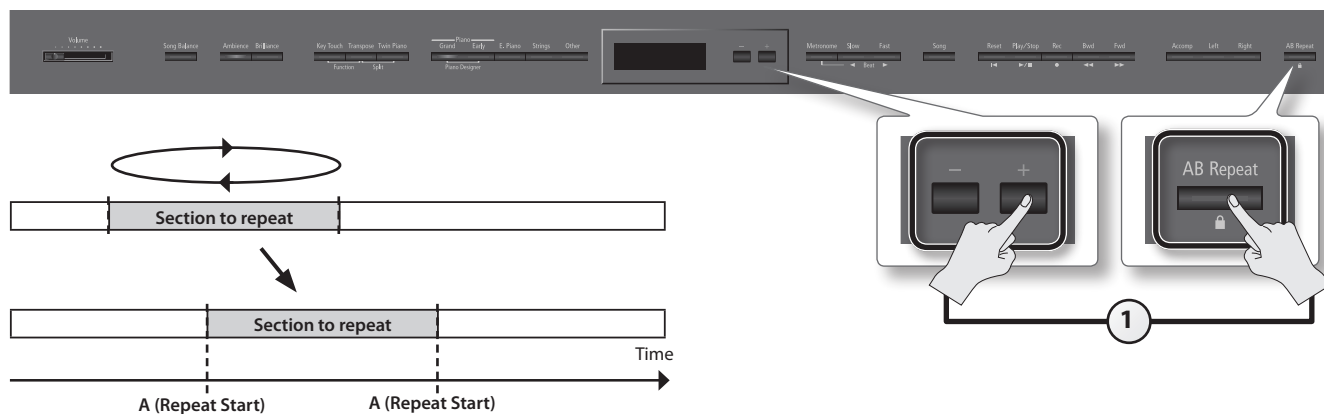

1. While holding down the [AB Repeat] button, press the [-] [+] buttons.  
The repeated portion will be moved without its length being changed.



## Recording the Song You're Practicing

It's easy to record your own performances.

You can play back a recorded performance to check your playing, or perform along with a recorded performance.

The LX-15 lets you record in the following ways.

Type of recording	Explanation
SMF recording	Parts will be separate. You can re-record a specific portion of the song. You can overdub. * Normally, you should use SMF recording.
Audio recording	Your performance will be recorded as audio data. The recorded song can be used on your computer. * In order to use audio recording, you must connect a USB flash drive (sold separately) to the USB memory connector (p. 11). * Thanks to its multiple number of speakers, each of which can be used to play a different portion of the overall sound, the LX-15 is capable of producing piano sounds that possess great depth and seem to have three-dimensional presence. Such effects are produced when you play something on the keyboard, or when you play back a song that's been recorded as an SMF. However, when you make an audio recording, the song will consist of two channels (stereo), and such effects cannot be reproduced.

\* SMFs (Standard MIDI Files) use a standard format for music file that was formulated so that files containing music file could be widely compatible, regardless of the manufacturer of the listening device. An enormous variety of music is available, whether it be for listening, for practicing musical instruments, for Karaoke, etc.

## SMF Recording

To record a new song, proceed as follows.

This method is convenient when you simply want to record your performance as easily as possible.

### Getting ready to record



1. Select the tone that you want to use for performing (p. 14).

2. Press the [●] (Rec) button.

The [●] (Rec) button will light, the [▶/■] (Play/Stop) button will blink, and the LX-15 will enter recording-standby mode.

If you decide not to record, press the [●] (Rec) button once again.

3. If desired, sound the metronome (p. 22).

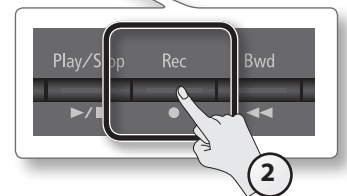

#### MEMO

If you change the metronome's tempo and time signature, they will be recorded with the song, allowing the metronome to sound correctly during playback.

### Starting/stopping recording



1. Press the [▶/■] (Play/Stop) button.

A two-measure count will be heard (the measure number will be shown as "-2" then "-1" in the lower right of the display), and then recording will start.

When recording starts, the [●] (Rec) button and [▶/■] (Play/Stop) button will light.

#### MEMO

You can also initiate recording by simply playing the keyboard. If you initiate recording by playing the keyboard, a count will not be sounded.

2. Press the [▶/■] (Play/Stop) button.

Recording will stop, and you'll be presented with a message asking you if you want to save the performance or erase it.



## Saving a performance you've recorded

1. Use the [+ ] button to select "Save."
2. Press the [Song] button.  
The media select screen will appear.
3. Use the [-] [+ ] buttons to select the save-destination media.

Indication	Save-destination media
Favorite	Internal memory
USB Memory	USB flash drive

4. Press the [▶] (Fast) button.  
A screen will appear, allowing you to select the song number of save destination.
5. Use the [-] [+ ] buttons to select the song number of save destination.  
No song has been saved in song numbers shown as (Empty) in the song name column.  
Choose a song number in which no song has been saved.  
If you want to save your song by overwriting an existing song you no longer need, select the song number of that unwanted song.

6. Press the [▶] (Fast) button.  
A screen will appear, allowing you to specify a name for your song.

7. Edit the name using the buttons shown in the illustration below.



Use the [Song] button to select the position at which you want to specify a character.

Use the [-] [+ ] buttons to change the character.

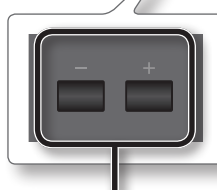

Change the character

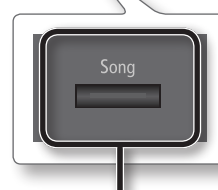

Select the character to change

8. When you've finished specifying a song name, press the [▶] (Fast) button to access the save-confirmation screen.
9. Press the [Song] button to save the song.  
If you decide not to save the song, press the [◀] (Slow) button.

### NOTE

Never turn off the power or disconnect the USB flash drive while the screen indicates "Executing..."

## Erasing a performance you've recorded

1. Use the [-] button to select "Erase."
2. Press the [Song] button to erase the song.

## Listening to a performance you've recorded

1. Press the [▶/■] (Play/Stop) button.  
Playback will start from the beginning of the recorded performance.



## Overdubbing a Recorded Song

When recording an SMF, you can overdub each part separately. For example, you can record the left-hand and right-hand parts separately, or record along with a song.

### Recording each hand separately

You can separately record your left-hand performance to the [Left] button and your right-hand performance to the [Right] button. You can also separately re-record each hand afterward.

#### Getting ready to record



1. Select the tone that you want to use for performing (p. 14).

2. Press the [●] (Rec) button.

The [●] (Rec) button will light, the [▶/■] (Play/Stop) button will blink, and the LX-15 will enter recording-standby mode.

If you decide not to record, press the [●] (Rec) button once again.

3. If desired, sound the metronome (p. 22).

**MEMO**

If you change the metronome's tempo and time signature, they will be recorded with the song, allowing the metronome to sound correctly during playback.

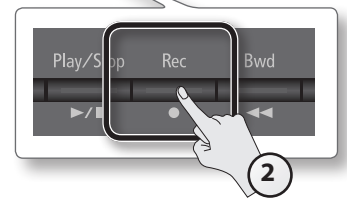

#### Recording the left hand



1. Press the [Right] button and the [Accomp] button so their illumination is turned off.

Only the [Left] button will be lit; you'll be able to record to the [Left] button.

- \* If you don't specify a part at this time, the recorded performance will be recorded in this order: [Right] button → [Left] button → [Accomp] button.
- \* If you're using Twin Piano or Split Play, the left side or left-hand tone will be recorded to the [Left] button, and the right side or right-hand tone will be recorded to the [Right] button.

2. Press the [▶/■] (Play/Stop) button.

A two-measure count will sound (the measure number in the lower right of the display will indicate "-2," then "-1"), and then recording will start. When recording starts, the [●] (Rec) button and [▶/■] (Play/Stop) button will light.

**MEMO**

You can also initiate recording by playing the keyboard. In this case, the count will not sound.

3. Press the [▶/■] (Play/Stop) button.

Recording will stop, and a confirmation message will ask whether you want to save or delete the recording.

4. Either save the performance or erase it (p. 29).

## Overdubbing the right hand



### 1. Press the [ ● ] (Rec) button.

The [ ● ] (Rec) button will light, and the LX-15 will enter recording-standby mode.

At this time, New Song will be selected.

If you decide not to record, press the [ ● ] (Rec) button once again.

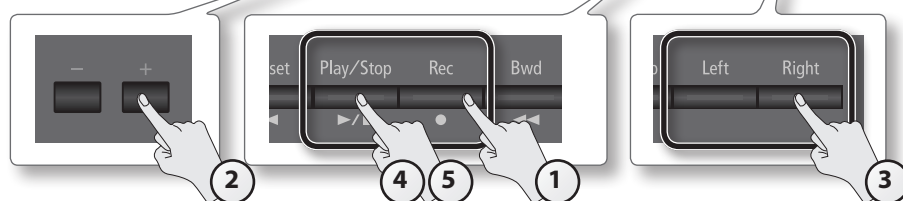

### 2. Reselect the song you saved earlier by pressing the [+] button.

#### MEMO

The song's tempo and time signature will be as they were when you recorded the left hand.

### 3. Press the [Right] button so it's blinking.

In this state, the right-hand performance will be recorded to the [Right] button. Leave the [Left] button lit.

#### NOTE

If you select a previously recorded part and then record, your new performance will overwrite that part; the previously recorded performance will be lost.

### 4. Press the [ ▶/■ ] (Play/Stop) button.

A two-measure count will be heard (the measure number will be shown as "-2" then "-1" in the lower right of the display), and then recording will start.

The previously recorded performance for the left hand will be played back, so you can listen to it while you play the right-hand part.

When recording starts, the [ ● ] (Rec) button and [ ▶/■ ] (Play/Stop) button will light.

#### MEMO

You can also initiate recording by playing the keyboard. In this case, the count will not sound.

### 5. Press the [ ▶/■ ] (Play/Stop) button.

Recording will stop, and a confirmation message will ask whether you want to save or delete the recording.

### 6. Either save the performance or erase it (p. 29).

## Recording a performance you play along with a song

Here's how you can record a performance that you play along with a song.

### Getting ready to record

1. Select the tone that you want record (p. 14).
2. Select the song to be dubbed (p. 24).

**MEMO**

If you want to erase the performance of a specific part, hold down its part button and press the [●] (Rec) button.

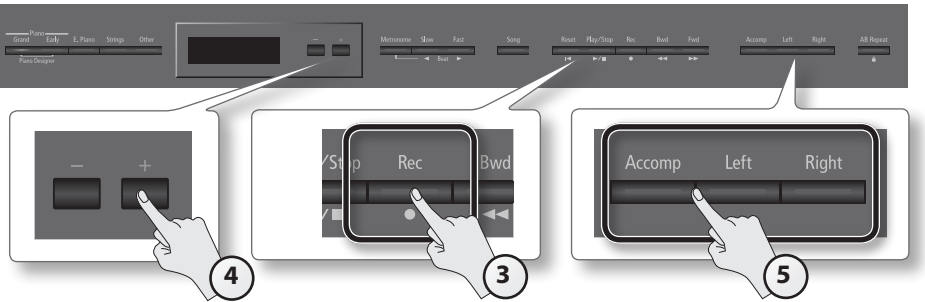

3. Press the [●] (Rec) button.  
The [●] (Rec) button will light, and the LX-15 will enter recording-standby mode.  
At this time, New Song will be selected.  
If you decide not to record, press the [●] (Rec) button once again.

4. Reselect the song selected in step 2 by pressing the [+] button.

**MEMO**

The song's tempo and time signature will be according to the settings of the song you selected.

5. Press the part button of the part that you want to record, so it's blinking.  
Parts whose buttons are lit will play back during recording.

### Starting/stopping recording



1. Press the [▶/■] (Play/Stop) button.  
A two-measure count will be heard (the measure number will be shown as "-2" then "-1" in the lower right of the display), and then recording will start.  
When recording starts, the [●] (Rec) button and [▶/■] (Play/Stop) button will light.

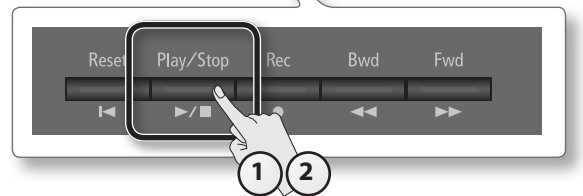

**MEMO**

You can also initiate recording by simply playing the keyboard. If you initiate recording by playing the keyboard, a count will not be sounded.

2. Press the [▶/■] (Play/Stop) button.  
Recording will stop, and a confirmation message will ask whether you want to save or delete the recording.
3. Either save the performance or erase it (p. 29).

## Converting a Song Recorded as an SMF to Audio

By converting a song recorded in the form of an SMF to audio, you'll be able to listen to it on your computer. You can also use your computer to burn the song to a music CD, or upload it to the Internet.

### Copying an audio recording of a song to your computer page 36

If you save an audio recording of a song on a USB flash drive, you'll be able to listen to it on your computer.

In order for an SMF song recording to be used on your computer, you'll need to convert it to audio (WAV file).

Audio recordings of songs are saved as WAVE files (16-bit, 44.1 kHz).

You can use your computer to burn them to a music CD or upload them to the Internet.

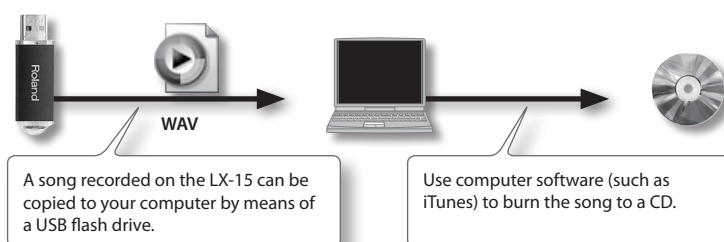

1. Connect a USB flash drive (sold separately) to the USB memory connector (p. 11).  
\* Audio data cannot be saved in the LX-15 itself.
2. Select the song that you want to convert to audio (p. 24).
3. While holding down the [●] (Rec) button, press the [-] [+] buttons to select "Audio."

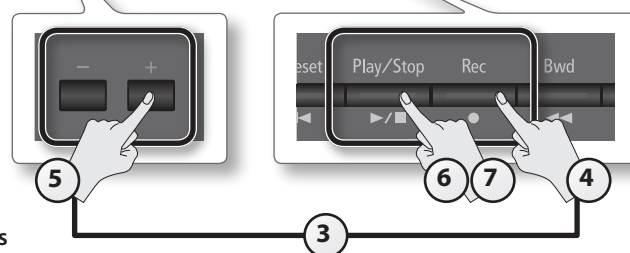

4. Press the [●] (Rec) button.  
The [●] (Rec) button will light, and the [▶/■] (Play/Stop) button will blink; the LX-15 will enter converting-standby mode. At this time, New Song will be selected.  
If you decide not to convert, press the [●] (Rec) button once again.
5. Reselect the song selected in step 2 by pressing the [+] button.
6. Press the [▶/■] (Play/Stop) button.  
Conversion will begin.

#### MEMO

If, during conversion, you play the keyboard, input something via the MIDI connector, or input sound via the Input jacks, all sound including those sounds will be converted. Muted parts will not be converted.

#### NOTE

- Never turn off the power or disconnect the USB flash drive during conversion.
- For some SMF recordings, it might not be possible to perfectly convert the recording in its original form.

7. Press the [▶/■] (Play/Stop) button.  
Conversion will be completed, and a confirmation message will ask whether you want to save or delete the file.
8. Either save the performance or erase it (p. 29).

## Audio Recording

Here's how to record what you play on the LX-15 as audio data. The recorded song can be used on your computer.

- \* Thanks to its multiple number of speakers, each of which can be used to play a different portion of the overall sound, the LX-15 is capable of producing piano sounds that possess great depth and seem to have three-dimensional presence. Such effects are produced when you play something on the keyboard, or when you play back a song that's been recorded as an SMF. However, when you make an audio recording, the song will consist of two channels (stereo), and such effects cannot be reproduced.

### Preparing to record



1. Connect a USB flash drive (sold separately) to the USB memory connector (p. 11).

\* Audio data cannot be saved in the LX-15 itself.

2. Select the tone that you want perform (p. 14).

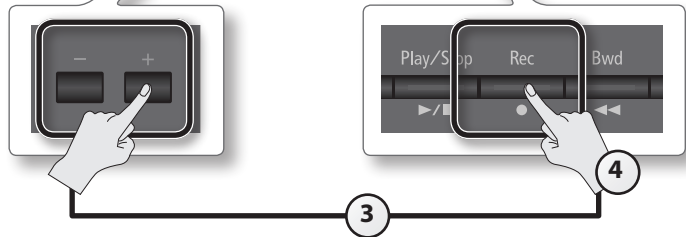

3. While holding down the [●] (Rec) button, press the [-] [+], [Rec], and [Play/Stop] buttons to select "Audio."



4. Press the [●] (Rec) button.

The [●] (Rec) button will light, the [▶/■] (Play/Stop) button will blink, and the LX-15 will enter recording-standby mode.

If you decide not to record, press the [●] (Rec) button once again.

5. If desired, sound the metronome (p. 22).

### Starting/stopping recording



1. Press the [▶/■] (Play/Stop) button.

Recording will start.

When recording starts, the [●] (Rec) button and [▶/■] (Play/Stop) button will light.

#### NOTE

Never turn off the power or disconnect the USB flash drive during recording.

2. Press the [▶/■] (Play/Stop) button.

Recording will stop, and a confirmation message will ask whether you want to save or delete the recording.

3. Either save the performance or erase it (p. 29).





## Transposing a Song for Easier Performance (Audio Transpose)

An audio recording of a song, or a song from a digital audio player connected to the Input jacks can be transposed to make it play back in a different key. You can play the keyboard while listening to the transposed sound.

### 1. Press the [Transpose] button.

The [Transpose] button will light.

### 2. While holding down the [Transpose] button, press the [-] [+] buttons.

The display will indicate the amount of transposition.

Screen	Value	Explanation
	-6~0~5(semitone units) (default: 1)	Positive (+) values raise the pitch in semitone steps, and negative (-) values lower the pitch in semitone steps.

#### MEMO

- Transposition will apply to the selected audio file and also to the sound of the digital audio player connected to the Input jacks.
- You can also use the Function mode's "Audio Transpose" setting to change the amount of transposition (p. 45).

\* If you select a different song, the audio transposition setting will be canceled.

### 3. To cancel the transposition, press the [Transpose] button once again.

The [Transpose] button will go out.

## Using a Digital Audio Player Song to Enjoy Karaoke (Center Cancel)

This function lets you minimize the melody of a song played back by a digital audio player connected to the Input jacks, allowing you to play the melody yourself on the keyboard, or use commercially available piano instruction CDs for piano lessons.

\* For some songs, it might not be possible to completely eliminate the melody sound.

### 1. Press the [Right] button.

The [Right] button will go out, and the melody sound will be minimized.

#### MEMO

- Center Cancel will apply both to the selected audio file and to the digital audio player that's connected to the Input jacks.
- You can also use the Function mode's "Center Cancel" setting to turn this off (p. 45).

\* The Center Cancel setting will turn off if you select a different song.

### 2. When you want the sound to be heard, press the [Right] button once again.

The [Right] button will light.

## Burning an Audio Recording of a Song (WAV file) to a CD

After an audio recording of a song has been saved to a USB flash drive, you can copy it to your computer and burn it to a CD. If you want to burn a CD from a song that you recorded as an SMF, you must first convert it to audio (WAV file) (p. 33).

In order to burn a CD on your computer, you'll need software such as "iTunes."

For details, refer to the owner's manual or the online help of your software.

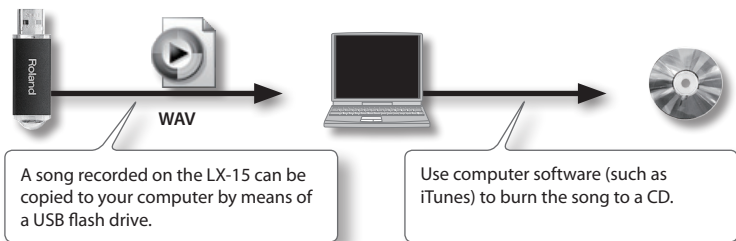

### Copy the recorded song to your computer

1. Connect the USB flash drive containing the song to your computer.

If you're using Windows, a "Removable disk" icon will appear in "Computer." If you're using Mac OS X, a "NO NAME" icon will appear on the desktop.



2. Double-click the icon that appeared.

The contents of the USB flash drive will be displayed.

The audio recording of the song (WAV file) will be among the contents.

3. Copy the song (WAV file) that you want to burn to CD to your computer's desktop or another location where you can easily find it.

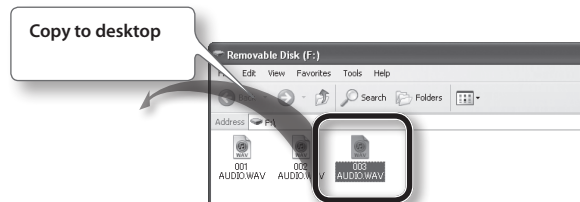

### Use iTunes to burn the song to CD

The following explanation uses iTunes 10 for Windows. If you're using a different version or other software, refer to its online help or owner's manual.

1. From the Start menu, click [All Programs] - [iTunes].
2. From the iTunes [File] menu, click [New Playlist] to create a playlist.

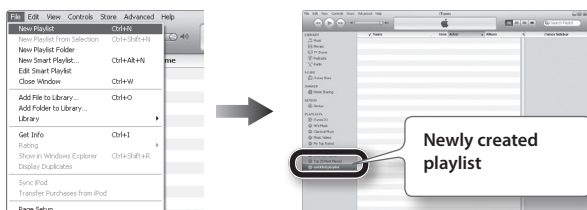

3. From the desktop (or other location) where you copied it, drag and drop the song (WAV file) to add it to the playlist you created in step 2.

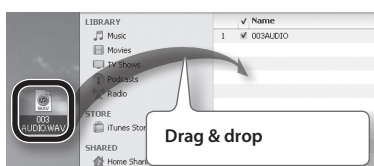

4. Insert a blank CD-R into your computer.

5. Select the playlist that you created in step 2, and in the [File] menu, click [Burn playlist to Disc].

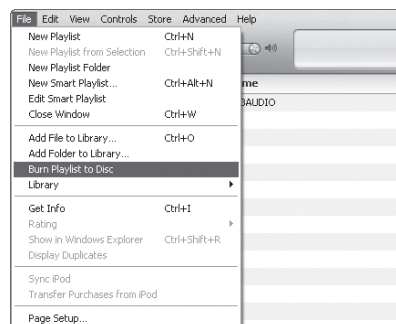

6. Make the appropriate settings in the disc creation dialog box, and then click the [Burn] button.

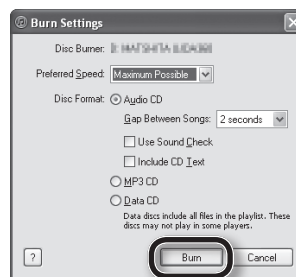

## Saving an Internal Song

Here's how to save an internal song to Favorite (internal memory) or a USB flash drive (sold separately).

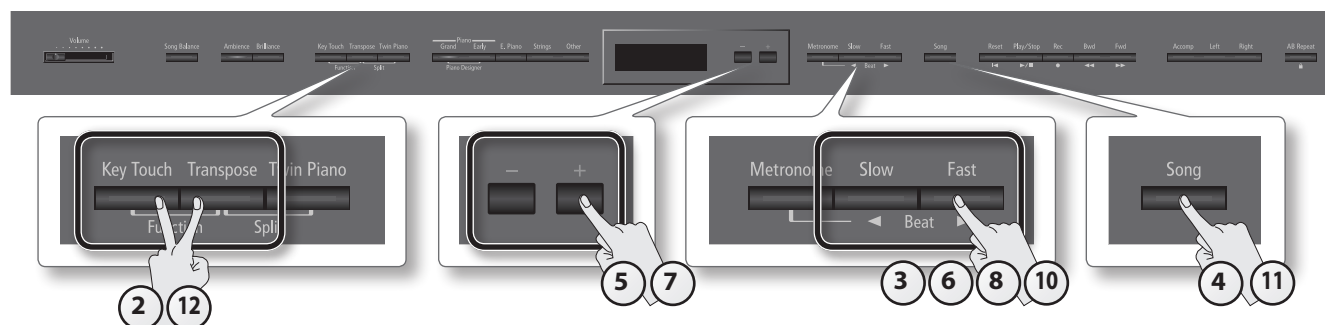

### Getting ready to save

1. Select the internal song that you want to save (p. 24).
2. While holding down the [Key Touch] button, press the [Transpose] button.  
The [Key Touch] button and [Transpose] button will light, and the LX-15 will enter Function mode.
3. Use the [◀] [▶] (Slow/Fast) buttons to select "Save Song."
4. Press the [Song] button.  
The media select screen will appear.
5. Use the [-] [+] buttons to select the save-destination media.
6. Press the [▶] (Fast) button.  
A screen will appear, allowing you to select the song number of save destination.
7. Use the [-] [+] buttons to select the song number of save destination.  
No song has been saved in song numbers shown as (Empty) in the song name column.  
Choose a song number in which no song has been saved.  
If you want to save your song by overwriting an existing song you no longer need, select the song number of that unwanted song.
8. Press the [▶] (Fast) button.  
A screen will appear, allowing you to specify the song name.

### Assigning a name to the song

9. Edit the song name using the buttons shown in the illustration below.

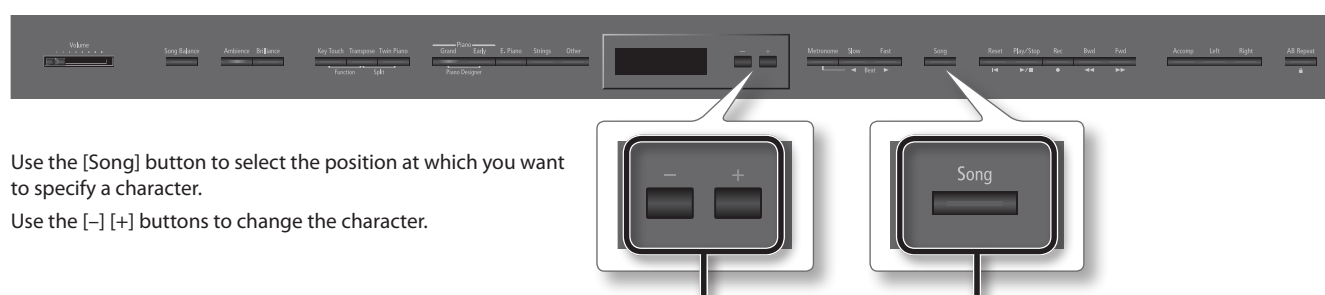

Use the [Song] button to select the position at which you want to specify a character.

Use the [-] [+] buttons to change the character.

### Save the song

10. When you've finished editing the song name, press the [▶] (Fast) button to access the save confirmation screen.
11. Press the [Song] button to save the song.  
If you decide not to save the song, press the [◀] (Slow) button.  
When the song has been saved, you will return to the screen of step 2.

#### NOTE

Never turn off the power or disconnect the USB flash drive while the screen indicates "Executing..."

12. Press the [Key Touch] button or the [Transpose] button to finish the procedure.

# Personalizing Your Piano Sound (Piano Designer)

## What is Piano Designer?

The LX-15 lets you adjust the piano sound to your taste by modifying various aspects of a grand piano's sound, such as its strings and pedal, as well as the keyboard resonances.

This function is called "Piano Designer."

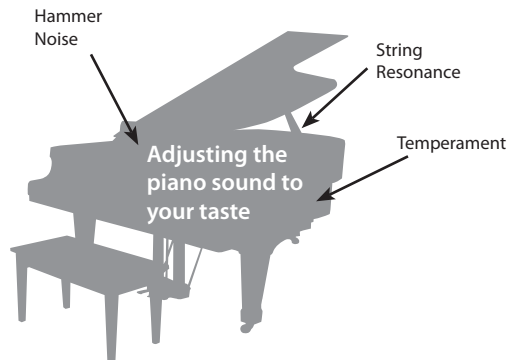

## Making Detailed Adjustments to the Piano Sound

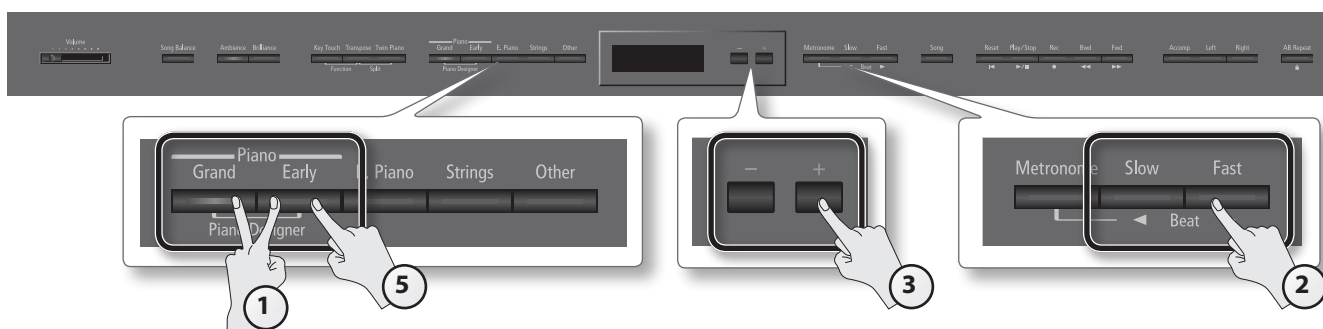

### 1. While holding down the Piano [Grand] button, press the Piano [Early] button.

The Piano Designer screen will appear.

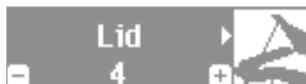

The "ConcertPiano" tone will be selected.

### 2. Press the [◀] [▶] (Slow/Fast) buttons to select the item that you want to edit.

### 3. Use the [-] [+] buttons to adjust the value.

### 4. Repeat steps 2–3 to adjust the piano sound to your taste.

### 5. When you're finished using Piano Designer, press the Piano [Grand] button or the Piano [Early] button.

#### Saving your settings

The LX-15's settings will revert to the default values when you turn off the power, but you can save them as described in "Retaining the Settings Even After Power-off (Memory Backup)" (p. 40).

## Piano designer parameter

Parameter	Value	Description
Lid	0–6 (default: 4)	Adjusts the extent to which the lid of the grand piano is open. The sound will become more mellow as you close the lid of the piano in the screen. The sound will become brighter as you open the lid of the piano in the screen.
Soundboard Behavior	Off, 1–10 (default: 5)	When you play a chord, this setting improves the clarity of the individual notes in the chord, creating a more beautiful resonance. Higher settings produce a clearer resonance.
Damper Resonance	Off, 1–10 (default: 5)	This adjusts the damper resonance of the acoustic piano sound (the sympathetic vibration produced in strings other than those actually played when you press the damper pedal). Higher settings will make the sympathetic vibration louder.
Hammer Noise	-2–0–2 (default: 0)	This adjusts the sound produced when the hammer of an acoustic piano strikes the string. Higher settings will produce a louder sound of the hammer striking the string.
Hammer Response	Off, 1–10 (default: 2)	This adjusts the time from when you play a key until the piano sound is heard. Higher settings will produce slower response.
Duplex Scale	Off, 1–10 (default: 5)	This adjusts the sympathetic vibrations of an acoustic piano's Duplex Scale. Higher settings will make the sympathetic vibration louder.

Parameter	Value	Description
String Resonance	Off, 1–10 (default: 5)	This adjusts the string resonance of the acoustic piano sound (the sympathetic vibrations of strings for previously played notes that occur when you play another note). Higher settings will make the sympathetic vibration louder.
Key Off Resonance	Off, 1–10 (default: 5)	This adjusts sympathetic vibrations such as an acoustic piano's key-off sound (the subtle sound that occurs when you release a note). Higher settings will make the sympathetic vibration louder.
Cabinet Resonance	Off, 1–10 (default: 4)	Adjusts the body resonance of the grand piano itself. Higher values will produce a larger body resonance.
Damper Noise	Off, 1–10 (default: 4)	This adjusts the damper noise of the acoustic piano sound (the sound of the damper releasing the strings when you press the damper pedal). * No damper noise will be heard if Damper Resonance is set to "Off".
Master Tuning	415.3–440.0–466.2 Hz (default: 440.0 Hz)	This adjusts the LX-15's standard pitch (the pitch of the middle A note). When playing ensemble with other instruments and in other such instances, you can match the standard pitch to another instrument. The standard pitch generally refers to the pitch of the note that's played when you finger the middle A key. For a cleaner ensemble sound while performing with one or more other instruments, ensure that each instrument's standard pitch is in tune with that of the other instruments. This tuning of all the instruments to a standard pitch is called "master tuning."
Temperament	Equal, Just Major, Just Minor, Pythagorean, Kirnberger, Meantone, Werckmeister, Arabic (default: Equal)	You can play classical styles such as Baroque using historic temperaments (tuning methods). Most modern songs are composed for and played in equal temperament, the most common tuning in use today. But at one time, there were a wide variety of other tuning systems in existence. By playing in the temperament that was in use when a composition was created, you can experience the sonorities of chords originally intended for that song. For details, refer to "Temperaments".
Temperament Key	C–B (default: C)	When playing with tuning other than equal temperament, you need to specify the temperament key for tuning the song to be performed (that is, the note that corresponds to C for a major key or to A for a minor key). If you choose an equal temperament, there's no need to select a temperament key.
Stretch Tuning	Off, Preset, User (User: -50–0–+50) (default: Preset)	This lets you specify the amount of "stretch tuning," a tuning method specifically for pianos, in which the high range is tuned slightly sharper, and the low range is tuned slightly flatter. If you select "Preset," a standard tuning curve created for the LX-15 will be used. If you select "User," you'll be able to edit the stretched tuning yourself. Play the key whose pitch you want to adjust, then use the [-] [+] buttons to adjust its pitch.
Piano Designer Demo	<p>For some parameters, you can listen to a demo song.</p> <ol style="list-style-type: none"> <li>In step 2, choose "Piano Designer Demo."</li> <li>Press the [Song] button.</li> <li>Use the [◀] [▶] (Slow/Fast) buttons to select the type of demo.</li> <li>Press the [▶/■] (Play/Stop) button. The demo will begin.</li> </ol>	

## Temperaments

Temperament	Qualities
Equal	In this tuning, each octave is divided into twelve equal steps. Every interval produces about the same amount of slight dissonance.
Just Major	This tuning eliminates ambiguities in the fifths and thirds. It is unsuited to playing melodies and cannot be transposed, but is capable of beautiful sonorities.
Just Minor	The Just tunings differ from major and minor keys. You can get the same effect with the minor scale as with the major scale.
Pythagorean	This tuning, devised by the philosopher Pythagoras, eliminates dissonance in fourths and fifths. Dissonance is produced by third-interval chords, but melodies are euphonious.
Kirnberger	This is an improvement of the Meantone and Just tunings that provides a high degree of freedom of modulation. Performances are possible in all keys (III).
Meantone	This scale makes some compromises in just intonation, enabling transposition to other keys.
Werckmeister	This temperament combines the Meantone and Pythagorean tunings. Performances are possible in all keys (first technique, III).
Arabic	This tuning is suitable for the music of Arabia.

## What is the duplex scale?

The Duplex Scale is a system of sympathetically vibrating strings sometimes included in grand pianos.

These sympathetically vibrating strings are not struck directly with hammers, but sound by vibrating in sympathy with the vibrations of other strings. By resonating with the overtones, these strings add richness and brilliance to the sound. These sympathetic strings are added only to the high register above approximately C4. Since they do not have a damper (a mechanism that stops them from sounding), they will continue sounding even after you play a note and then release it to stop the sound of the string that was actually struck.

## Adjusting the Brightness of the Display (Display Contrast)

You can adjust the brightness of the LX-15's display.

1. While holding down the [Key Touch] button, press the [Transpose] button.
2. Use the [◀] [▶] (Slow/Fast) buttons to select "Display Contrast."



3. Use the [-] [+] buttons to change the setting.

Value
1-10 (default: 5)

\* This setting is automatically stored in the LX-15.

4. Press the [Key Touch] button or the [Transpose] button to finish the procedure.

## Making the Power Automatically Turn Off After a Time (Auto Off)

With the factory settings, the LX-15's power will automatically be switched off 30 minutes after you stop playing or operating the unit.

If you don't need the power to turn off automatically, set "Auto Off" to the "Off" setting as described below.

1. While holding down the [Key Touch] button, press the [Transpose] button.
2. Use the [◀] [▶] (Slow/Fast) buttons to select "Auto Off."

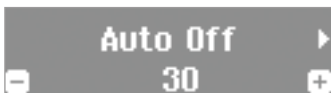

3. Use the [-] [+] buttons to change the setting.

Value	Explanation
10	The power will automatically turn off if no operation is performed for 10 minutes.
30 (default)	The power will automatically turn off if no operation is performed for 30 minutes.
240	The power will automatically turn off if no operation is performed for 240 minutes (4 hours).
Off	The power will not turn off automatically.

\* This setting is automatically stored in the LX-15.

4. Press the [Key Touch] button or the [Transpose] button to finish the procedure.

### NOTE

When turning the unit's power back on after it has been shut down due to the Auto Off function, always make sure to allow at least five seconds to pass after the power has been shut off before you turn the power back on. If you turn it back on too rapidly, the Auto Off function will not have had enough time to reset itself, and you may not be able to turn on the power in the normal way.

## Retaining the Settings Even After Power-off (Memory Backup)

The settings of the LX-15 will return to their factory-set state when you turn off the power. However, you can store the settings so that they will be retained even after the power is turned off.

This is called the "memory backup" function.

Parameters Stored in Memory Backup	Page
Piano designer settings	p. 38
Ambience (on/off, depth)	p. 18
Brilliance (on/off, depth)	p. 19
Split Point	p. 17
Twin Piano mode	p. 20
Key Touch (on/off, value)	p. 19
Dual Balance	p. 44
Transpose Mode	p. 45
Damper Pedal Part	p. 45
MIDI Transmit Channel	p. 46
Visual Control Channel	p. 48

1. While holding down the [Key Touch] button, press the [Transpose] button.
2. Use the [◀] [▶] (Slow/Fast) buttons to select "Memory Backup."

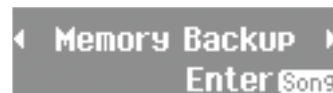

3. Press the [Song] button.  
The Memory Backup screen will appear.



4. Press the [+] button to select "OK."
5. To execute the function, press the [Song] button.

If you decide to cancel without executing, press the [-] button to select "Cancel" and press the [Song] button.

When the memory backup has been completed, the screen of step 2 will appear.

### NOTE

Never turn off the power while the screen indicates "Executing..."

6. Press the [Key Touch] button or the [Transpose] button to finish the procedure.

## Restoring the Factory Settings (Factory Reset)

Settings that you've stored using the Memory Backup function (p. 40) can be returned to their factory-set state. This is called the "factory reset" function.

**NOTE**

When you execute "Factory Reset," all stored settings will be erased and returned to the factory settings.

**MEMO**

This function will not erase the songs from Favorite (internal memory) or USB flash drive (sold separately). If you want to erase Favorite or USB flash drive, "Initializing the Memory (Format Media)" (p. 42).

1. While holding down the [Key Touch] button, press the [Transpose] button.
2. Use the [◀] [▶] (Slow/Fast) buttons to select "Factory Reset."

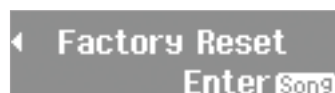

3. Press the [Song] button. The Factory Reset screen will appear.



4. Press the [+] button to select "OK."
5. To execute the function, press the [Song] button.

If you decide to cancel without executing, press the [-] button to select "Cancel" and press the [Song] button.

When the factory reset has been completed, the screen will indicate "Power Off, then On."

**NOTE**

Never turn off the power while the screen indicates "Executing..."

6. Turn the power off, then on again (p. 13).

## Copying a Saved Song (Copy Song)

Songs that have been saved in Favorite (internal memory) can be copied to USB flash drive (sold separately). Alternatively, songs stored on a USB flash drive can be copied to Favorite.

\* Audio files cannot be copied.

1. While holding down the [Key Touch] button, press the [Transpose] button.
2. Press the [◀] [▶] (Slow/Fast) button to choose "Copy Song."

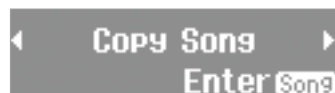

3. Press the [Song] button. The Copy Song screen will appear.



4. Use the [-] [+] buttons to select the copy-source and copy-destination memory locations.

5. Press the [▶] (Fast) button.



6. Press the [-] [+] button to select the song that you want to copy.

**MEMO**

If you choose "Copy All," all songs except for audio files in the copy-source memory will be copied.

7. Press the [▶] (Fast) button.



8. Use the [-] [+] buttons to select the copy-destination number.

No song has been saved at song numbers for which (Empty) is shown as the song name.

Select a song number at which no song has been saved.

If you want to delete an unwanted song and replace it with the song you're copying, select the unwanted song number.

9. Press the [▶] (Fast) button.

A confirmation message will appear.



10. Press the [Song] button to copy the song.

If you decide not to copy, press the [◀] (Slow) button.

Once the song has been copied, you'll be returned to the screen of step 2.

**NOTE**

Never turn off the power or disconnect the USB flash drive while the screen indicates "Executing..."

11. Press the [Key Touch] button or the [Transpose] button to finish the procedure.



## Deleting a Saved Song (Delete Song)

Here's how to delete a song that you saved on an Favorite (internal memory) or USB flash drive (sold separately).

**MEMO**

If you want to delete all songs that have been saved to Favorite, initialize the memory.

1. While holding down the [Key Touch] button, press the [Transpose] button.
2. Use the [◀] [▶] (Slow/Fast) buttons to select "Delete Song."

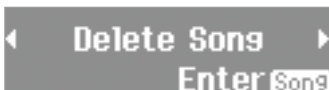

3. Press the [Song] button.

The Delete Song screen will appear.

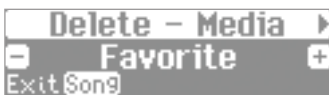

4. Use the [-] [+] buttons to select the memory location that contains the song you want to delete.
5. Press the [▶] (Fast) button.



6. Use the [-] [+] buttons to select the song that you want to delete.
7. Press the [▶] (Fast) button.

A confirmation message will appear.

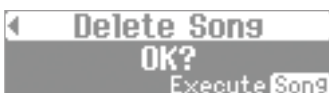

8. Press the [Song] button to delete the song.

If you decide not to delete, press the [◀] (Slow) button.

Once the song is deleted, you'll be returned to the screen you were in at step 2.

**NOTE**

Never turn off the power or disconnect the USB flash drive while the screen indicates "Executing..."

9. Press the [Key Touch] button or the [Transpose] button to finish the procedure.

## Initializing the Memory (Format Media)

Here's how you can completely erase all songs that were saved in Favorite (internal memory) or USB flash drive (sold separately).



**NOTE**

- Once an initialization is performed, all songs that have been saved in Favorite (internal memory) or USB flash drive will be erased. The erased data cannot be recovered, so we recommend that you check the contents of memory before you proceed.
- If you're using new USB flash drive (sold separately) with the LX-15 for the first time, you'll need to initialize (format) the USB flash drive before using it. The LX-15 can't use USB flash drive that has not been initialized.

If you want to format USB flash drive, connect the USB flash drive to the USB memory connector (p. 11).

1. While holding down the [Key Touch] button, press the [Transpose] button.
2. Use the [◀] [▶] (Slow/Fast) buttons to select "Format Media."

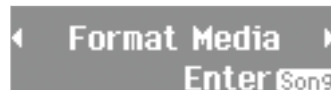

3. Press the [Song] button.

The Format Media screen will appear.



4. Use the [-] [+] buttons to select the memory that you want to initialize.
5. Press the [▶] (Fast) button.

A confirmation message will appear.



6. Press the [Song] button to initialize the media.

If you decide not to initialize, press the [◀] (Slow) button.

Once the initialization is finished, you'll be returned to the screen you were in at step 2.

7. Press the [Key Touch] button or the [Transpose] button to finish the procedure.



### Caution when initializing the memory

- Never turn off the power while “Executing...” is shown in the display.
- If the screen indicates “Error,” please refer to “Error Messages” (p. 60).
- Initializing the LX-15's Favorite will not initialize settings other than the contents of Favorite. If you want to return settings other than the contents of Favorite to their factory-set condition, execute the Factory Reset operation (p. 41).
- Don't disconnect the USB flash drive until USB flash drive initialization has been completed.

## Disabling the Buttons (Panel Lock)

When you activate Panel Lock, all buttons will be disabled. This prevents the tones or settings from being changed if you inadvertently press a button.

### 1. Hold down the [AB Repeat] button for a while.

Panel Lock will be activated.

The upper right of the display will show a “” symbol, and all button operations will be disabled.



### 2. To cancel Panel Lock, once again hold down the [AB Repeat] button for a while.

Panel Lock will also be cancelled when you turn off the power.

- \* If you activate Panel Lock while a song is playing or being recorded, playback or recording will stop.
- \* You can't activate Panel Lock while in Function mode (p. 44) or while in the Demo Song screen.

# Various Settings (Function Mode)

The same procedure is used for all settings in Function mode.

1. While holding down the [Key Touch] button, press the [Transpose] button.

The [Key Touch] button and [Transpose] button will light; the LX-15 will be in Function mode.

2. Press the [◀] [▶] (Slow/Fast) buttons to select the function setting that you want to change.

3. Press the [-] [+] button to edit the value of the setting.

4. Press the [Key Touch] button or the [Transpose] button to exit Function mode.

Indication	Value	Explanation
Auto Off		<h2>Making the Power Automatically Turn Off After a Time (Auto Off) (p. 40)</h2> <p>With the factory settings, the unit's power will automatically be switched off 30 minutes after you stop playing or operating the unit. If you don't want the power to turn off automatically, change the "Auto Off" setting to "Off" as follows.</p> <p><b>MEMO</b> This setting is automatically saved in the LX-15.</p>
Master Tuning		<h2>Matching the Pitch with Other Instruments (Master Tuning)</h2> <p>When playing ensemble with other instruments and in other such instances, you can match the standard pitch to another instrument. The standard pitch generally refers to the pitch of the note that's played when you finger the middle A key. For a cleaner ensemble sound while performing with one or more other instruments, ensure that each instrument's standard pitch is in tune with that of the other instruments. This tuning of all the instruments to a standard pitch is called "master tuning."</p> <p>415.3 Hz–440.0 Hz–466.2 Hz</p>
Temperament		<h2>Changing the Tuning Method (Temperament)</h2> <p>You can play classical styles such as Baroque using historic temperaments (tuning methods). Most modern songs are composed for and played in equal temperament, the most common tuning in use today. But at one time, there were a wide variety of other tuning systems in existence. By playing in the temperament that was in use when a composition was created, you can experience the sonorities of chords originally intended for that song. For details, refer to "Temperaments" (p. 39).</p> <p>Equal, Just Major, Just Minor, Pythagorean, Kirnberger, Meantone, Werckmeister, Arabic</p>
Temperament Key		<h2>Specifying a Song's Tonic (Temperament Key)</h2> <p>When playing with tuning other than equal temperament, you need to specify the temperament key for tuning the song to be performed (that is, the note that corresponds to C for a major key or to A for a minor key). If you choose an equal temperament, there's no need to select a temperament key.</p> <p>C–B</p>
Dual Balance		<h2>Adjusting the Dual Play Volume Balance (Dual Balance)</h2> <p>When using Dual Play, you can adjust the volume balance between tone 1 and tone 2.</p> <div style="border: 1px solid black; padding: 5px; width: fit-content;"> <p><b>How to save your settings?</b> Save your settings as described in "Memory Backup" (p. 40).</p> </div> <p>9-1 (tone 1 is louder)–9-9 (same volume)–1-9 (tone 2 is louder)</p>
Master Gain		<h2>Adjusting the Volume (Master Gain)</h2> <p>If you are playing the LX-15 through a connected external system, there may be cases in which the volume from your external system is too low even when the LX-15's volume is turned to the maximum setting. In such cases, you can adjust the master gain setting as follows. Adjusting the master gain will also affect the volume of the internal speakers and headphones.</p> <p>* The sound may distort if you increase the volume excessively.</p> <p>-12–0–12 dB</p>
Input Volume		<h2>Adjusting the Volume of an Audio Playback Device (Input Volume)</h2> <p>You can adjust the volume of an audio playback device that's connected to the Input jacks.</p> <p>0–10</p>

Indication	Value	Explanation
Center Cancel	<b>Playing Back an Audio File with Its Central Sound Minimized (Center Cancel)</b>	
	You can minimize the playback of sounds located in the center of the sound field (e.g., vocals or melody instruments) of the selected audio file or music from a digital audio player connected to the Input jacks. * For some songs, sounds located in the center might not disappear completely, or the tone quality of the sound might be affected.	
	<b>MEMO</b> You can also turn the Center Cancel function on/off by pressing the [Right] button.	
	On	Sound at center reduced during playback.
	Off	Normal playback.
Audio Transpose	<b>Transposing an Audio File (Audio Transpose)</b>	
	The selected audio file and the sound of a digital audio player connected to the Input jacks can both be transposed for playback. * For some songs, an audio transpose setting other than 0 may affect the tone quality of the sound.	
	<b>MEMO</b> You can also change this setting by holding down the [Transpose] button and using the [-] [+] buttons.	
	-6-0-5(semi-tone units)	Positive (+) values raise the pitch in semitone steps, and negative (-) values lower the pitch in semitone steps.
Transpose Mode	<b>Specifying What the Transpose will Affect (Transpose Mode)</b>	
	This setting specifies what the transpose will affect. You can use the transpose to change the pitch of both the song and the keyboard, the pitch of only the song, or the pitch of only the keyboard.	
	<b>How to save your settings?</b> Save your settings as described in "Memory Backup" (p. 40).	
	Keyboard	The sound of the keyboard
	Song	The song being played back and the sound being input via the Input jacks
	Keyboard & Song	The sound of the keyboard, the song being played back, and the sound being input via the Input jacks
Octave Shift	<b>Changing the Pitch of the Tone in Octave Steps (Octave Shift)</b>	
	You can change the pitch of the Tone 2 in Dual Play (p. 15) and Lower tone in Split Play (p. 16) an octave at a time. Altering the pitch in one-octave units in this way is called "Octave Shift." For example, you can raise the pitch of the Lower Tone to the same pitch of the Upper Tone in Split Play.	
	-2-0-+2 (octave)	
Recording Mode	<b>Selecting the Format for Recording (Recording Mode)</b>	
	You can choose whether to record as SMF or as audio.	
	<b>MEMO</b> You can also switch the recording mode by holding down the [●] (Rec) button and using the [-] [+] buttons.	
	SMF	SMF parts will be recorded separately. This allows you to re-record just a single part, or to overdub different parts.
	Audio	The recording will be made as audio data. The recorded song can be used in your computer.
Damper Pedal Part	<b>Changing How the Pedal Effects Are Applied (Damper Pedal Part)</b>	
	When you press the damper pedal during Dual play or Split play, the pedal effect is normally applied to both tones, but you can also select the tone to which the effect is to be applied.	
	<b>How to save your settings?</b> Save your settings as described in "Memory Backup" (p. 40).	
	Right & Left	All enabled
	Right	Applied only to the Tone 1 (in dual mode)/Right-hand Tone (in split mode)
	Left	Applied only to the Tone 2 (in dual mode)/Left-hand Tone (in split mode)

## Various Settings (Function Mode)

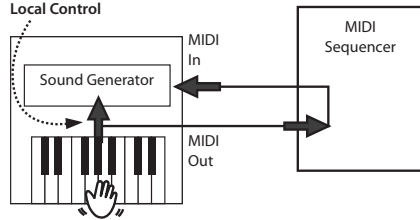
Indication	Value	Explanation
<b>Changing How the Pedals Work (Center Pedal)</b>		
Center Pedal	When you turn on the power, the center pedal functions as the sostenuto pedal (p. 10). You can change the function of the pedal to a variety of other operations.	
	Sostenuto	Sets function to sostenuto pedal. * Selectable only for the center pedal.
	Play/Stop	The pedal will have the same function as the [ ▶/■ ] (Play/Stop) button.
	Layer	Pressing the pedal will layer on Tone 2, used for Dual play. * The Layer function can be applied only when using Dual play.
	Octave	Pressing the pedal will layer on a sound one octave higher. * The Octave function cannot be applied while using Twin Piano, Dual play, or Split play.
<b>Preventing Doubled Notes When Connected to a Sequencer (Local Control)</b>		
Local Control	When you have a MIDI sequencer connected, set this parameter to Local Off. Since most sequencers have their Thru function turned on, notes you play on the keyboard may be sounded in duplicate, or get dropped. To prevent this, you can enable the "Local Off" setting so that the keyboard and internal sound generator will be disconnected.	
		
	On	Local Control is on. The keyboard and composer are connected to the internal sound generator.
Off	Local Control is off. The keyboard and composer are disconnected from the internal sound generator. Playing the keyboard will not produce sound.	
<b>MIDI Transmit Channel Settings (MIDI Transmit Channel)</b>		
MIDI Transmit Channel	This setting specifies the MIDI channel on which the LX-15 will transmit. MIDI uses sixteen "MIDI channels," which are numbered 1 through 16. By connecting MIDI devices and specifying the appropriate MIDI channel for each device, you can play or select sounds on those devices. The LX-15 will receive all sixteen channels (1–16).	
	Off, 1–16	<div style="border: 1px solid black; padding: 5px; width: fit-content;"> <p><b>How to save your settings?</b> Save your settings as described in "Memory Backup" (p. 40).</p> </div>

Indication	Value	Explanation
------------	-------	-------------

CD/Audio Type	<b>Setting the Type of CD To be Played Back (CD/Audio Type)</b>	
	<p>The LX-15 may be unable to correctly recognize the type of CD being used. In such instances, you can specify the type of CD manually. When the unit left the factory, this was set to "Stereo." Normally, there is no need to make this setting.</p> <p><b>MEMO</b> This setting is automatically saved in the LX-15.</p>	

### Installing the CD Drive

Attach the CD drive as shown the figure, using the mounting holes on the LX-15's bottom panel.

- \* For details of the attachment or connecting, refer to the owner's manual of the CD drive.
- \* Use a CD drive sold by Roland. We cannot guarantee operation if any other CD drive is used.

**NOTE**

- You cannot play back CD-R/RW disks to which audio tracks have been added or CDs containing both audio tracks and data (CD Extra).
- The LX-15 is capable of playing back only commercial CDs that conform the official standards-those that carry the "COMPACT DISC DIGITAL AUDIO" logo.
- The usability and sound quality of audio discs that incorporate copyright protection technology and other non-standard CDs cannot be guaranteed.
- For more detailed information on audio discs featuring copyright protection technology and other non-standard CDs, please consult the disc vendor.
- You cannot save songs and styles to CDs, and you cannot delete songs or styles recorded to CDs. Furthermore, you cannot format CDs.

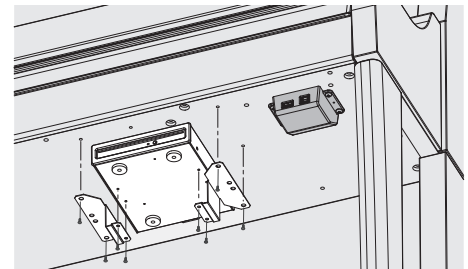

Save Song	<b>Saving an Internal Song (Save Song) (p. 37)</b>	
	You can save an internal song to Favorite or a USB flash drive.	

Copy Song	<b>Copying a Saved Song (Copy Song) (p. 41)</b>	
	A song you've saved to Favorite can be copied to a USB flash drive. Alternatively, a song saved to a USB flash drive can be copied to Favorite.	

Delete Song	<b>Deleting a Saved Song (Delete Song) (p. 42)</b>	
	You can delete a saved song from Favorite or a USB flash drive.	

Format Media	<b>Initializing the Memory (Format Media) (p. 42)</b>	
	You can delete all songs from Favorite or a separately sold USB flash drive.	

USB Driver	<b>Changing the USB Driver Settings (USB Driver)</b>	
	<p>Normally, you don't need to install a driver in order to connect the LX-15 to your computer. However, if some problem occurs, or if the performance is poor, using the Roland original driver may solve the problem. After setting "USB Driver" to "Original" on the LX-15, install the driver on your personal computer. After changing this setting, you need to turn off the LX-15, then turn it back on again.</p> <p><b>MEMO</b> This setting is automatically saved in the LX-15.</p> <p>For details on downloading and installing the Roland original driver, refer to the Roland website.</p> <p>Roland website: <a href="http://www.roland.com/">http://www.roland.com/</a></p>	



Generic	Choose this if you want to use the standard USB driver that was included with your computer. Normally, you should use this mode.
	Choose this if you want to use a USB driver downloaded from the Roland website.

Original	Choose this if you want to use a USB driver downloaded from the Roland website.
----------	---

## Various Settings (Function Mode)

Indication	Value	Explanation
USB Memory Mode	<b>Changing the USB flash drive Setting (USB Memory Mode)</b>	
	<p>In some cases, when USB flash drive is connected to the USB memory connector, it may take longer for data to be loaded, or data may fail to be loaded successfully. If this occurs, you may be able to solve the problem by changing the USB flash drive setting.</p> <p>When the unit left the factory, this was set to "Mode 2" Normally, there is no need to make this setting.</p> <p><b>MEMO</b> This setting is automatically saved in the LX-15.</p>	
Visual Control Mode	<b>Controlling Video Equipment (Visual Control Mode)</b>	
	<p>Visual Control is a function that lets you control images along with your performance. If you've set Visual Control mode to MVC or V-LINK, playing the keyboard of LX-15 will control the images produced by the Visual Control device connected to LX-15 using a MIDI cable.</p>	
	Off	Visual Control is off.
	MVC	MIDI Visual Control mode is selected.
Visual Control Channel	<b>Specifying the Visual Control Channel (Visual Control Channel)</b>	
	<p>Here's how to specify the channel on which messages used to control video will be sent. (Visual Control Channel).</p>	
	1-16	Specifies the MIDI channel used to transmit MIDI messages to the Visual Control device.

### How to save your settings?

Save your settings as described in "Memory Backup" (p. 40).

### What is MIDI visual control?

MIDI Visual Control is an internationally-used recommended practice that was added to the MIDI specification so that visual expression could be linked with musical performance. Video equipment that is compatible with MIDI Visual Control can be connected to electronic musical instruments via MIDI in order to control video equipment in tandem with a performance.



### What is V-LINK?

V-LINK is Roland's proprietary specification that allows visual expression to be linked with musical performance. Video equipment that is compatible with V-LINK can be connected to electronic musical instruments via their MIDI ports, making it easy to enjoy a variety of visual effects that are linked with the performance.



### Connection examples

Connect a MIDI cable from this unit's MIDI Out connector (p. 11) to the MIDI In connector of your Visual Control compatible device.

\* You'll need a MIDI cable (sold separately) in order to connect this unit to a device that supports Visual Control.

### Visual control function chart

Playing the lowest 12 keys of this unit (A0-G#1) will transmit the following MIDI messages.

Visual Control function	Transmitted MIDI message	LX-15's operation
Switch images	CC 0 (Bank Select): 0-4	Play black keys
	Program Change: 1-7	Play white keys

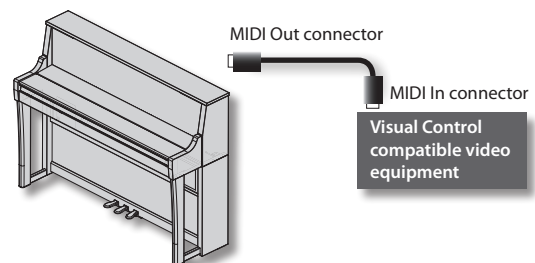

Indication	Value	Explanation
Display Contrast		<p><b>Adjusting the Brightness of the Display (Display Contrast) (p. 40)</b></p> <p>You can adjust the brightness of the LX-15's display.</p> <p><b>MEMO</b> This setting is automatically saved in the LX-15.</p>
Memory Backup		<p><b>Storing Your Settings (Memory Backup) (p. 40)</b></p> <p>The LX-15's settings will return to their default settings when you turn off the power, but you can store these settings so that they will retain the changes you made even after the power is turned off, then on again.</p>
Factory Reset		<p><b>Restoring the Factory Settings (Factory Reset) (p. 41)</b></p> <p>When you execute the "Factory Reset" function, the settings you've edited in Function mode will be restored to their factory-set state.</p>

# Troubleshooting

Symptom	Cause/Action	Page
Even though you're using headphones and the sound is muted, a thumping sound is heard when you play the keyboard	LX-15 uses a hammer action keyboard in order to simulate an acoustic piano's playing touch as realistically as possible. For this reason, you'll hear the hammers thump when you play the keyboard, just as you would when playing an acoustic piano. Since this unit allows you to adjust its volume, you might notice the sound of the hammers in certain situations, but this does not indicate a malfunction. If vibration transmitted to the floor or walls is a concern, you may be able to minimize the vibration by moving the piano away from the wall, or by laying down a commercially available anti-vibration mat designed for use with pianos.	-
Power turns off on its own	When 30 minutes have elapsed since you last played or operated this unit, the power will turn off automatically. (This is the factory setting). If you don't need the power to turn off automatically, turn the "Auto Off" setting "Off."	p. 40
Power does not turn on	Is the power cord connected correctly?	p. 58
	Could you have turned the power on again immediately after turning the power off? Allow an interval of at least five seconds before turning the power on again.	-
Screen display is irregular when power is turned on/off	Since the LX-15 uses a liquid-crystal display, you may find that it is unable to display letters or other things in environments where temperatures go below 0 degrees Celsius (32 degrees Fahrenheit).	-
Pedal does not work, or is "stuck"	Is the pedal connected correctly? Plug the cable firmly into the pedal connector.	p. 59
	If you disconnect the pedal cord from the LX-15 while the power is on, the pedal effect may remain "stuck" in the On condition. You must power-off the LX-15 before connecting or disconnecting the pedal cord.	p. 59
	Could you have changed how the pedal effect is applied? If the damper pedal part is set to Right, the pedal will apply only to the right tone; if it is set to Left, the pedal will apply only to the left tone.	p. 45
	Could Twin Piano be turned on? If Twin Piano is on, the right pedal will affect only the right-hand keyboard zone and the left pedal will affect only the left-hand keyboard zone.	p. 20
	Could you have changed the function of the pedal? If you've switched the function of the soft pedal or sostenuto pedal, these pedals will not operate as the soft pedal or sostenuto pedal.	p. 46
	Unable to read from/write to USB flash drive	Are you using (optional) Roland USB flash drive? Reliable performance cannot be guaranteed if you use non-Roland USB flash drive products. If you are unable to read or write USB flash drive successfully, change the USB memory mode.
"Buzz" is heard from external devices	Are the external devices connected to more than one AC power outlet? If you connect external devices, be sure to connect them to the same AC outlet.	-
The volume level of the instrument connected to Input jacks is too low.	Could the Input volume be set to "0"?	p. 44
	Could you be using a connection cable that contains a resistor? Use a connection cable that does not contain a resistor.	-
<b>No sound</b>		
No sound	Is the speaker cable connected correctly?	p. 59
	Could the LX-15's volume or the volume of the connected equipment be turned down?	p. 13
	Could headphones be connected? Could there be a plug inserted in a headphone jack? The speakers will not produce sound if headphones or plug are connected to the headphone jacks.	p. 11
	Has Local Control been set to "Off"? When Local Control is set to Off, no sound is produced by playing the keyboard. Set Local Control to On.	p. 46
	Could Twin Piano mode be set to "Individual"? If headphones are connected when Twin Piano is "On" and the mode is set to "Individual," notes played in the left-hand keyboard zone will not be heard from the headphones connected to the right Phones jack. Similarly, notes played in the right-hand keyboard zone will not be heard from the headphones connected to the left Phones jack.	p. 20
	Has Local Control been set to "Off"? When Local Control is set to Off, no sound is produced by playing the song. Set Local Control to On.	p. 46
No sound when you play back a song	Could the song volume be set to "0"?	p. 25
No sound from the leftmost notes of the keyboard	Could the Visual Control mode be set to MVC or V-LINK? If the Visual Control mode is set to MVC or V-LINK, the lowest 12 keys of the keyboard (A0-G#1) are used to control images; they will not produce sound.	p. 48
	Are all devices powered on? Are the MIDI cables connected correctly? Do the MIDI channels of the LX-15 and the connected device match?	- p. 11 p. 46
<b>Notes don't sound right</b>		
Sound is not loud enough Only the high sounds are heard	Is the speaker cable connected correctly?	p. 58
Pitch of the keyboard or song is incorrect	Could you have made Transpose settings?	p. 21 p. 35
	Is the Master Tune setting appropriate?	p. 39
	Is the setting for the Temperament correct?	p. 39
	Is the settings for the Stretch Tuning correct?	p. 39
Not all the notes you play are sounded	The maximum simultaneous polyphony is 128 voices. If you are playing along with a song and making heavy use of the damper pedal, the number of notes the LX-15 is attempting to produce may exceed the maximum polyphony, meaning that some of the notes will drop out.	-
Sounds are heard twice (doubled) when the keyboard is played	Is the LX-15 in Dual play?	p. 15
	When the LX-15 is connected to an external sequencer, set the Local Control to off. Alternatively, the sequencer could be set so its Soft Thru feature is Off.	p. 46



Symptom	Cause/Action	Page
The wrong instrument is selected when you press the [E. Piano], [Strings], or [Other] button	Tone buttons [E. Piano] [Strings] [Other] also operate as buttons that select "Recommended Tones." Connecting a commercially-available CD-ROM drive to the USB flash drive connector and selecting a song from a CD-ROM produced for the VIMA (VIMA TUNES) will automatically cause sounds appropriate for that song to be assigned to the [E. Piano], [Strings], and [Other] Tone buttons, so that you can select "recommended" sounds by pressing one of these buttons.	p. 14
Effect does not apply	When you are using Dual play or Split play, and different effects are specified for the two selected tones, the effect will not be applied to Tone 2 (when using Dual play) or the left-hand tone (when using Split play).	-
Reverberation remains even if You defeat the Ambience effect	The LX-15's piano sound faithfully simulates the depth and resonance of an acoustic piano, and this may give the impression of reverberation even if you've defeated the Ambience effect. Also, you may be able to eliminate some reverberation by reducing the value set for "Cabinet Resonance."	p. 39
The sound of the higher notes suddenly changes from a certain key	On an acoustic piano, the approximately one and a half octaves of notes at the top of the keyboard will continue sounding regardless of the damper pedal. These notes also have a somewhat different tonal character. LX-15 faithfully simulate this characteristic of acoustic pianos. On the LX-15, the range that is unaffected by the damper pedal will change according to the key transpose setting.	-
High-pitched ringing is heard	Is the speaker cable connected correctly?	p. 58
	<b>If you hear this in headphones:</b> Piano sounds that have a brilliant and crisp character contain substantial high-frequency components that may sound as though a metallic ringing has been added. This is because the character of an actual piano is being faithfully reproduced, and is not a malfunction. This ringing is more obtrusive if the ambience effect is applied heavily, so you may be able to minimize it by decreasing the ambience. <b>If you don't hear this in headphones:</b> It is likely that there is some other reason (such as resonances within the unit). Please contact your dealer or a nearby Roland service center.	-
Low notes sound wrong, or are buzzy	If you set the volume to the maximum setting, the sound may be distorted depending on how you perform. If this occurs, turn down the volume. Alternatively, lower the master gain.	p. 44
	<b>If you don't hear this in headphones:</b> Performing at high volumes may cause the speakers or objects near the LX-15 to resonate. Fluorescent lights or glass doors may also resonate sympathetically. In particular, this is more likely to occur for lower notes and higher volumes. You can take the following measures to minimize resonances. • Locate the speakers 10–15 cm (4–6 inch) away from walls or other surfaces. • Keep the volume down. • Move away from the objects that are resonating. <b>If you hear this in headphones:</b> It is likely that there is some other reason. Please contact your dealer or a nearby Roland service center.	-
<b>Song does not play correctly</b>		
Only the sound of a particular instrument in a song does not play	Could a part be muted? If the button indicator is out, the music on that part is not heard. Press the part button so the indicator is illuminated.	p. 26
Sound is heard from a muted part	Could the part mute volume be set to other than "0"? If you set this to "0," the sound of a muted part will be completely inaudible.	p. 26
Song volume is low	Could the song volume be lowered?	p. 25
Can't play back a song saved in USB flash drive	Could the Audio files of the format be played? Audio files of the following format can be played back. • File extension ".WAV" • 16-bit linear • "44.1 kHz" sampling rate	-
	Is the filename extension ".MID"? Files with other filename extensions cannot be handled as song data.	-
Song tempo becomes unstable	When playing a song from USB flash drive, the tempo may become unstable if there is an excessive amount of performance data.	-
Song name in USB flash drive is not shown	The song name will not be shown if the song information in the file is empty or consists only of spaces.	-
	Is the filename extension ".MID"? Files with other filename extensions cannot be handled as song data.	-
<b>Can't record / play back</b>		
Can't record SMF	Has one of the part buttons for recording been selected?	p. 28
Can't record audio	Is a USB flash drive connected to the USB memory connector?	-
Tone quality of the piano sound changes when you record a performance as audio	Thanks to its multiple number of speakers, each of which can be used to play a different portion of the overall sound, the LX-15 is capable of producing piano sounds that possess great depth and seem to have three-dimensional presence. Such effects are produced when you play something on the keyboard, or when you play back a song that's been recorded as an SMF. However, when you make an audio recording, the song will consist of two channels (stereo), and such effects cannot be reproduced.	-
The recorded performance disappeared	Your recorded performance will disappear if you switch off the LX-15's power or select a song. There is no way to recover the lost performance. Before you turn off the power, save your recorded performance in Favorite or USB flash drive.	-
<b>Limitations regarding audio files</b>		
<ul style="list-style-type: none"> <li>• Ambience (p. 18)</li> <li>• Saving to Favorite (p. 29)</li> <li>• Playback (muting) of individual parts (p. 26)</li> <li>• Copy Song (p. 41)</li> </ul>		

# Tone List

## Piano—Grand

No.	Tone Name	Explanation
1	ConcertPiano	The sound of a splendid concert grand piano. This piano sound has our highest recommendation, and can be used for any style of music.
2	BalladePiano	A mellow grand piano sound, recommended for quiet songs.
3	Bright Piano	A brilliant grand piano sound, recommended when you want the piano to stand out in an ensemble.
4	MagicalPiano	A charming sound that layers synth bells with ConcertPiano.
5	Piano + Str.	Strings layered with ConcertPiano.
6	Piano + Pad	A pad layered with ConcertPiano.
7	Piano+Choir	A choir layered with ConcertPiano.
8	Pure Piano	A grand piano sound notable for its clarity. When using headphones, this will sound the same as the ConcertPiano.
9	Rock Piano	A robust piano sound, recommended for boogie-woogie playing.
10	RagtimePiano	A honky-tonk piano sound, recommended for ragtime playing.

## Piano—Early

No.	Tone Name	Explanation
1	Fortepiano	An early type of piano with a distinctive sound that's somewhat different than today's pianos.
2	Mellow Forte	A mellow fortepiano sound.
3	Bright Forte	A brilliant fortepiano sound.
4	Dolcechord	A dream-like sound that can sound like a piano or a harpsichord.
5	Harpsichord	A type of keyboard instrument widely used in Baroque music, producing a delicate sound.
6	Harpsi 8'+4'	The sound of a harpsichord layered with sound an higher octave.

## E. Piano

No.	Tone Name
1	Tremolo EP
2	Pop E.Piano
3	Vintage EP
4	FM E.Piano
5	EP Belle
6	'60s E.Piano
7	Clav.
8	Stage Phaser
9	'70s E.Piano
10	E.Grand

## Strings

No.	Tone Name
1	SymphonicStr
2	Epic Strings
3	Rich Strings
4	OrchestraStr
5	Orchestra
6	ChamberWinds
7	Harp
8	Violin
9	Velo Strings
10	Flute
11	Cello
12	OrchestraBrs
13	PizzicatoStr
14	DecayStrings *

\* Tones indicated by "\*" are suitable for playing layered with a piano tone.

## Other

No.	Tone Name
1	Vibraphone
2	Celesta
3	Jazz Scat
4	SymphonicCho
5	Pipe Organ
6	Nason flt 8'
7	Combo Jz.Org
8	Ballad Organ
9	Soft Pad
10	Harpvox
11	Nylon-str.Gt
12	Steel-str.Gt
13	Marimba
14	Mallet Isle
15	Morning Lite
16	Ballad Bells
17	Accordion
18	ChurchOrgan1
19	ChurchOrgan2
20	Aerial Choir
21	Angels Choir
22	Beauty Vox
23	Female Aahs
24	Male Aahs
25	Decay Choir *

No.	Tone Name
26	Thum Voice
27	Gospel Spin
28	Full Stops
29	Mellow Bars
30	Light Organ
31	Lower Organ
32	'60s Organ
33	Glass Pad
34	Lunar Strngs
35	Dcy ChoirPad *
36	Jazz Guitar
37	AcousticBass
38	A.Bass+Cymb
39	FingeredBass
40	BrassSection
41	Alto Sax
42	Tenor Sax

\* Tones numbered 43 and higher are accompaniment-use GM2 tones.

\* In the tone group "Other" when you hold down the [-] [+] buttons to switch tone in succession, the tones will stop changing at number 43 and number 52.

\* To select the next sound, release the [-] [+] buttons, then press it again.

# Internal Song List

No.	Song Title	Composer
<b>MASTERPIECE</b>		
1	Sonate für Klavier Nr.23 1	Ludwig van Beethoven
2	Sonate für Klavier Nr.23 2	Ludwig van Beethoven
3	Sonate für Klavier Nr.23 3	Ludwig van Beethoven
4	Floral Pursuits *	John Maul
5	Barcarolle	Fryderyk Franciszek Chopin
6	Zhavoronok	Mikhail Ivanovich Glinka, Arranged by Mily Alexeyevich Balakirev
7	Valse, op.34-1	Fryderyk Franciszek Chopin
8	Polonaise op.53	Fryderyk Franciszek Chopin
9	Nocturne No.20	Fryderyk Franciszek Chopin
10	Die Forelle	Franz Peter Schubert, Arranged by Franz Liszt
11	Reflets dans l'Eau	Claude Achille Debussy
12	La Fille aux Cheveux de Lin	Claude Achille Debussy
13	La Campanella	Franz Liszt
14	Scherzo No.2	Fryderyk Franciszek Chopin
15	Étude, op.10-12	Fryderyk Franciszek Chopin
16	Sonate No.15	Wolfgang Amadeus Mozart
17	Liebesträume 3	Franz Liszt
18	Étude, op.10-3	Fryderyk Franciszek Chopin
19	Je te veux	Erik Satie
20	Valse, op.64-1	Fryderyk Franciszek Chopin
21	Golliwog's Cakewalk	Claude Achille Debussy
22	Fantaisie-Impromptu	Fryderyk Franciszek Chopin
23	Arabesque 1	Claude Achille Debussy
24	An der schönen, blauen Donau	Johann Strauss, Sohn
25	Auf Flügeln des Gesanges	Felix Mendelsshon
26	Mazurka No.5	Fryderyk Franciszek Chopin
27	Gymnopédie 1	Erik Satie
28	Étude, op.25-1	Fryderyk Franciszek Chopin
29	Clair de Lune	Claude Achille Debussy
30	Étude, op.10-5	Fryderyk Franciszek Chopin
31	Dr. Gradus ad Parnassum	Claude Achille Debussy
32	Grande Valse Brillante	Fryderyk Franciszek Chopin
33	La prière d'une Vierge	Tekla Badarzewska
34	Course en Troïka	Peter Ilyich Tchaikovsky
35	To The Spring	Edvard Hagerup Grieg
36	Valse, op.64-2	Fryderyk Franciszek Chopin
37	Radetzky Marsch	Johann Baptist Strauss
38	Träumerei	Robert Alexander Schumann
39	Moments Musicaux 3	Franz Peter Schubert
40	Prélude, op.28-15	Fryderyk Franciszek Chopin
41	Harmonious Blacksmith	Georg Friedrich Händel
42	Ungarische Tänze 5	Johannes Brahms
43	Türkischer Marsch	Ludwig van Beethoven
44	Nocturne No.2	Fryderyk Franciszek Chopin
45	Frühlingslied	Felix Mendelsshon
46	Präludium	Johann Sebastian Bach
47	Jägerlied	Felix Mendelsshon
48	Passepied	Claude Achille Debussy
49	Für Elise	Ludwig van Beethoven
50	Türkischer Marsch	Wolfgang Amadeus Mozart
51	Ständchen	Franz Peter Schubert
52	Humoreske	Antonín Dvořák
53	Blumenlied	Gustav Lange
54	Alpenglöckchen	Theodor Oesten

No.	Song Title	Composer
55	Menuett G dur	Ludwig van Beethoven
56	Venezianisches Gondellied	Felix Mendelsshon
57	Alpenabendröte	Theodor Oesten
58	Farewell to the Piano	Ludwig van Beethoven
59	Brautchor	Wilhelm Richard Wagner
60	Forget-Me-Not	Heinrich Lichner
61	Wiener Marsch	Carl Czerny
62	Le Coucou	Louis Claude Daquin
63	Menuett G dur	Johann Sebastian Bach
64	Spinnerlied	Albert Ellmenreich
65	Gavotte	François Joseph Gossec
66	Heidenröslein	Gustav Lange
67	Zigeuner Tanz	Heinrich Lichner
68	La Cinquantaine	Gabriel Marie
69	Csikos Post	Hermann Necke
70	Dolly's Dreaming Awakening	Theodor Oesten
71	La Violette	Louis Streabbog
72	Fröhlicher Landmann	Robert Alexander Schumann
73	Sonatine op.36-1	Muzio Clementi
74	Sonatine op.20-1	Friedrich Kuhlau
75	Sonatine No.5	Ludwig van Beethoven
<b>CZERNY 100</b>		
1-100	Czerny 100	Carl Czerny
<b>HANON</b>		
1-20	Hanon 1-20	Charles Hanon

\* All rights reserved. Unauthorized use of this material for purposes other than private, personal enjoyment is a violation of applicable laws.

\* No data for the music that is played will be output from MIDI Out and USB connector.

\* Songs marked by an asterisk (\*) are original songs composed for the Roland Corporation. The copyrights to these songs are owned by the Roland Corporation.

\* MASTERPIECE 1-3, 5-15 are piano solos. They have no accompaniment.

# Main Specifications

## Roland LX-15: Digital Piano

Keyboard	
Keyboard	88 keys (PHA III Ivory Feel Keyboard with Escapement)
Touch Sensitivity	Key Touch: 100 types, Fixed Touch Hammer Response: Off, 10 levels
Keyboard Mode	Whole Dual (volume balance adjustable) Split (split point adjustable) Twin Piano
Pedals	
Pedals	Damper (Progressive Damper Action Pedal, capable of continuous detection) Soft (capable of continuous detection) Sostenuto (function assignable)
Sound Generator	
Piano Sound	SuperNATURAL Piano Sound
Sound Generator	Conforms to GM2/GS/XG Lite
Max. Polyphony	128 voices
Tones	Grand Piano: 10 tones Early Piano: 6 tones E. Piano: 10 tones Strings: 14 tones Other: 307 tones (including 8 drum sets, 1 SFX set)
Temperament	8 types, selectable temperament Key
Stretched Tuning	Preset, User tuning (adjustable in individual notes: -50.0–+50.0 cent), Off
Master Tuning	415.3 Hz–466.2 Hz (adjustable in increments of 0.1 Hz)
Transpose	Key Transpose: -6–+5 (in semitones) Playback Transpose: -6–+5 (in semitones)
Effects	Ambience (Off, 10 levels) Brilliance (Off, -10–+10) <b>Only for Piano Tones (Piano Designer):</b> Open/close lid (7 levels) Soundboard Behavior (Off, 10 levels) Cabinet Resonance (Off, 10 levels) Hammer Noise (5 levels) Damper Noise (Off, 10 levels) Duplex Scale (Off, 10 levels) Damper Resonance (Off, 10 levels) String Resonance (Off, 10 levels) Key Off Resonance (Off, 10 levels) <b>Only for Organ Tones:</b> Rotary Speaker Effect (Slow/Fast)
Metronome	
Tempo	Quarter note = 10 to 500
Beat	2/2, 0/4, 2/4, 3/4, 4/4, 5/4, 6/4, 7/4, 3/8, 6/8, 9/8, 12/8
Volume	11 levels
SMF Recorder	
Tracks	3 tracks
Save Song	Standard MIDI Files (Format 0)
Songs	Recorder section: 1 song Internal Memory: Max. 99 songs
Note Storage	Approx. 30,000 notes
Control	Song Select, Play/Stop, Rec, Rewinding, Fast-forwarding, Previous song, Next song, Track Mute, Mute Volume, Tempo, Tempo Mute, All Songs Play, Count-in, Song Balance, AB Repeat
Tempo	Tempo: Quarter note= 10 to 500
Resolution	120 ticks per quarter note
Audio/Audio CDs	
Playback	Yes File Format: Audio File (WAV 44.1 kHz/16-bit linear format) Audio CDs (CD-DA) (when using optional CD drive)
Recording	Yes (with Keyboard, SMF data, Audio from Input jacks) File Format: Audio File (WAV 44.1 kHz/16-bit linear format)
Transpose	Playback Transpose (with Audio from Input jacks): -6–+5 (in semitones)
Tempo	Audio Playback Speed: 75–125 %
Control	Song Select, Play/Stop, Rec, Rewinding, Fast-forwarding, Previous song, Next song, Tempo, All Songs Play, Song Balance, AB Repeat, Center Cancel (with Audio from Input jacks)



Internal Memory (Favorite)	
Songs	Max. 99 songs
Save Song	Standard MIDI Files (Format 0)
External Memory	
External Storage	USB Flash Memory Floppy Disk (when using optional floppy disk drive)
Playable Software	Standard MIDI Files (Format 0/1) Roland Original Format (i-Format) Audio File (WAV 44.1 kHz/16-bit linear format) Audio CDs (CD-DA) (when using optional CD drive)
Save Song	Standard MIDI Files (Format 0) Audio File (WAV 44.1 kHz/16-bit linear format)
Others	
Internal Songs	Piano Masterpieces: 75 songs Hanon: 20 songs Czerny #100: 100 songs
Rated Power Output	60 W x 2 20 W x 2
Volume Level (SPL)	110 dB * These figures were measured according to the method that is based on Roland's technical standard.
Speakers	16 cm x 2 with Speaker box 5 cm x 2 (8 cm x 12 cm) x 2
Display	Graphic monochrome LCD 122 x 32 dots (with backlight)
Language	English
Control	Volume (Slider)
Other Functions	Panel Lock MIDI VISUAL CONTROL V-LINK
Connectors	AC inlet Pedal connector Input jacks (L/Mono, R): RCA phono type Output jacks (L/Mono, R): 1/4-inch phone type USB COMPUTER connector USB MEMORY connector MIDI connectors (In, Out) Phones jack (Stereo, with Twin Piano Individual Mode) x 2: Stereo 1/4-inch phone type
Power Consumption	38 W (36 W–85 W) (with top lid close) 1,408 (W) x 472 (D) x 1,070 (H) mm 55-7/16 (W) x 18-5/8 (D) x 42-1/8 (H) inches (with top lid open) 1,408 (W) x 483 (D) x 1,128 (H) mm 55-7/16 (W) x 19-1/16 (D) x 44-7/16 (H) inches
Dimensions (including piano stand)	
Weight (including piano stand)	91 kg/200 lbs 10 oz
Accessories	Owner's Manual Power Cord Headphones Hook (*1) *1 Supplied with the stand.
Options (sold separately)	USB CD Drive (CD-01A) USB Floppy Disk Drive (FD-01A)

\* In the interest of product improvement, the specifications and/or appearance of this unit are subject to change without prior notice.







# USING THE UNIT SAFELY

## INSTRUCTIONS FOR THE PREVENTION OF FIRE, ELECTRIC SHOCK, OR INJURY TO PERSONS

### About WARNING and CAUTION Notices

 <b>WARNING</b>	Used for instructions intended to alert the user to the risk of death or severe injury should the unit be used improperly.
 <b>CAUTION</b>	Used for instructions intended to alert the user to the risk of injury or material damage should the unit be used improperly. * Material damage refers to damage or other adverse effects caused with respect to the home and all its furnishings, as well to domestic animals or pets.

### About the Symbols

	The  symbol alerts the user to important instructions or warnings. The specific meaning of the symbol is determined by the design contained within the triangle. In the case of the symbol at left, it is used for general cautions, warnings, or alerts to danger.
	The  symbol alerts the user to items that must never be carried out (are forbidden). The specific thing that must not be done is indicated by the design contained within the circle. In the case of the symbol at left, it means that the unit must never be disassembled.
	The  symbol alerts the user to things that must be carried out. The specific thing that must be done is indicated by the design contained within the circle. In the case of the symbol at left, it means that the power-cord plug must be unplugged from the outlet.

### ALWAYS OBSERVE THE FOLLOWING

#### WARNING

Do not open or perform any internal modifications on the unit.



Do not attempt to repair the unit, or replace parts within it (except when this manual provides specific instructions directing you to do so). Refer all servicing to your retailer, the nearest Roland Service Center, or an authorized Roland distributor, as listed on the "Information" page.



Never install the unit in any of the following locations.

- Subject to temperature extremes (e.g., direct sunlight in an enclosed vehicle, near a heating duct, on top of heat-generating equipment); or are
- Damp (e.g., baths, washrooms, on wet floors); or are
- Exposed to steam or smoke; or are
- Subject to salt exposure; or are
- Humid; or are
- Exposed to rain; or are
- Dusty or sandy; or are
- Subject to high levels of vibration and shakiness.



Make sure you always have the unit placed so it is level and sure to remain stable. Never place it on stands that could wobble, or on inclined surfaces.



The unit should be connected to a power supply only of the type described as marked on the rear panel of unit.



Use only the attached power-supply cord. Also, the supplied power cord must not be used with any other device.



Do not excessively twist or bend the power cord, nor place heavy objects on it. Doing so can damage the cord, producing severed elements and short circuits. Damaged cords are fire and shock hazards!



This unit, either alone or in combination with an amplifier and headphones or speakers, may be capable of producing sound levels that could cause permanent hearing loss. Do not operate for a long period of time at a high volume level, or at a level that is uncomfortable. If you experience any hearing loss or ringing in the ears, you should immediately stop using the unit, and consult an audiologist.



Do not place containers containing liquid on this product. Never allow foreign objects (e.g., flammable objects, coins, wires) or liquids (e.g., water or juice) to enter this product. Doing so may cause short circuits, faulty operation, or other malfunctions.



#### WARNING

Immediately turn the power off, remove the power cord from the outlet, and request servicing by your retailer, the nearest Roland Service Center, or an authorized Roland distributor, as listed on the "Information" page when:

- The power-supply cord or the plug has been damaged; or
- If smoke or unusual odor occurs
- Objects have fallen into, or liquid has been spilled onto the unit; or
- The unit has been exposed to rain (or otherwise has become wet); or
- The unit does not appear to operate normally or exhibits a marked change in performance.



In households with small children, an adult should provide supervision until the child is capable of following all the rules essential for the safe operation of the unit.



Protect the unit from strong impact. (Do not drop it!)



Do not force the unit's power-supply cord to share an outlet with an unreasonable number of other devices. Be especially careful when using extension cords—the total power used by all devices you have connected to the extension cord's outlet must never exceed the power rating (watts/ amperes) for the extension cord. Excessive loads can cause the insulation on the cord to heat up and eventually melt through.



Before using the unit in a foreign country, consult with your retailer, the nearest Roland Service Center, or an authorized Roland distributor, as listed on the "Information" page.



#### CAUTION

The unit should be located so that its location or position does not interfere with its proper ventilation.



Always grasp only the plug on the power-supply cord when plugging into, or unplugging from, an outlet or this unit.



At regular intervals, you should unplug the power plug and clean it by using a dry cloth to wipe all dust and other accumulations away from its prongs. Also, disconnect the power plug from the power outlet whenever the unit is to remain unused for an extended period of time. Any accumulation of dust between the power plug and the power outlet can result in poor insulation and lead to fire.



#### CAUTION

Try to prevent cords and cables from becoming entangled. Also, all cords and cables should be placed so they are out of the reach of children.



Never climb on top of, nor place heavy objects on the unit.



Never handle the power cord or its plugs with wet hands when plugging into, or unplugging from, an outlet or this unit.



If you need to move the instrument, take note of the precautions listed below. At least two persons are required to safely lift and move the unit. It should be handled carefully, all the while keeping it level. Make sure to have a firm grip, to protect yourself from injury and the instrument from damage.



- Check to make sure the screws securing the unit to the stand have not become loose. Fasten them again securely whenever you notice any loosening.

- Disconnect the power cord.

- Disconnect all cords coming from external devices.

- Raise the adjusters on the stand (p. 58).

- Close the lid and the top lid.

Before cleaning the unit, turn off the power and unplug the power cord from the outlet (p. 58).



Whenever you suspect the possibility of lightning in your area, pull the plug on the power cord out of the outlet.



Be careful when opening/closing the lid and the top lid so you do not get your fingers pinched (p. 12). Adult supervision is recommended whenever small children use the unit.



When using the stool, please observe the following points:



- Do not use the stool as a toy, or as a stepping stool.

- Do not allow two or more persons to sit on the stool.



- Do not adjust the height while sitting on the stool.

- Do not sit on the stool if the bolts holding the stool legs are loose. (If the bolts are loose, immediately re-tighten them).

- Never insert your hand into the gap (the metal height adjustment mechanism) under the seat lid. Doing so may cause your hand to be pinched or injured.

To prevent accidental ingestion of the parts listed below, always keep them out of the reach of small children.



- Removable Parts  
Screws for stand assembly (p. 58)

Around the display may become hot, so take care to avoid burns.





# IMPORTANT NOTES

## Power Supply

- Do not connect this unit to same electrical outlet that is being used by an electrical appliance that is controlled by an inverter (such as a refrigerator, washing machine, microwave oven, or air conditioner), or that contains a motor. Depending on the way in which the electrical appliance is used, power supply noise may cause this unit to malfunction or may produce audible noise. If it is not practical to use a separate electrical outlet, connect a power supply noise filter between this unit and the electrical outlet.
- Before connecting this unit to other devices, turn off the power to all units. This will help prevent malfunctions and/or damage to speakers or other devices.
- Although the LCD and LEDs are switched off when the POWER switch is switched off, this does not mean that the unit has been completely disconnected from the source of power. If you need to turn off the power completely, first turn off the POWER switch, then unplug the power cord from the power outlet. For this reason, the outlet into which you choose to connect the power cord's plug should be one that is within easy reach and readily accessible.
- With the factory settings, the LX-15's power will automatically be switched off 30 minutes after you stop playing or operating the unit. If you don't want the power to turn off automatically, change the "Auto Off" setting to "Off" as described on "Making the Power Automatically Turn Off After a Time (Auto Off)" (p. 40).

## Placement

- Using the unit near power amplifiers (or other equipment containing large power transformers) may induce hum. To alleviate the problem, change the orientation of this unit; or move it farther away from the source of interference.
- This device may interfere with radio and television reception. Do not use this device in the vicinity of such receivers.
- Noise may be produced if wireless communications devices, such as cell phones, are operated in the vicinity of this unit. Such noise could occur when receiving or initiating a call, or while conversing. Should you experience such problems, you should relocate such wireless devices so they are at a greater distance from this unit, or switch them off.
- Do not expose the unit to direct sunlight, place it near devices that radiate heat, leave it inside an enclosed vehicle, or otherwise subject it to temperature extremes. Also, do not allow lighting devices that normally are used while their light source is very close to the unit (such as a piano light), or powerful spotlights to shine upon the same area of the unit for extended periods of time. Excessive heat can deform or discolor the unit.
- When moved from one location to another where the temperature and/or humidity is very different, water droplets (condensation) may form inside the unit. Damage or malfunction may result if you attempt to use the unit in this condition. Therefore, before using the unit, you must allow it to stand for several hours, until the condensation has completely evaporated.
- Do not allow rubber, vinyl, or similar materials to remain on this unit for long periods of time. Such objects can discolor or otherwise harmfully affect the finish.
- Do not allow objects to remain on top of the keyboard. This can be the cause of malfunction, such as keys ceasing to produce sound.

- Do not paste stickers, decals, or the like to this instrument. Peeling such matter off the instrument may damage the exterior finish.
- Do not put anything that contains water (e.g., flower vases) on this unit. Also, avoid the use of insecticides, perfumes, alcohol, nail polish, spray cans, etc., near the unit. Swiftly wipe away any liquid that spills on the unit using a dry, soft cloth.

## Maintenance

- To clean the unit, use a dry, soft cloth; or one that is slightly dampened. Try to wipe the entire surface using an equal amount of strength, moving the cloth along with the grain of the wood. Rubbing too hard in the same area can damage the finish.
- Never use benzine, thinners, alcohol or solvents of any kind, to avoid the possibility of discoloration and/or deformation.
- The pedals of this unit are made of brass. Brass eventually darkens as the result of the natural oxidization process. If the brass becomes tarnished, polish it using commercially available metal polisher.

## Maintenance (Polished-finish pianos)

- Since your piano has a polished finish that is as delicate as that found on finely crafted wooden furniture, it needs careful, periodic care. A few important suggestions concerning the proper care of the unit follow. For dusting, using a soft, clean cloth and/or piano-use feather duster. Be sure to wipe gently. Even the tiniest grains of sand or grit can leave scratches on the surface if too much force is applied while wiping. Do not use any cleaners or detergents, since they might deteriorate the surface of the cabinet, and produce cracks.

If the cabinet's surface loses its luster, wipe it thoroughly with a soft cloth dampened with a little of the polishing liquid. Do not use any cleaners or detergents, since they might deteriorate the surface of the cabinet, and produce cracks. Do not use dusting cloths that contain chemicals.

- About piano polishing liquid
  - Use polishing liquid as directed by the instructions for the product.
  - Use only polishing liquid that is intended for use on polished-finish pianos. Using any other polishing liquid may cause scratches, deformation, or discoloration. To purchase polishing liquid, contact your nearby musical instrument dealer.
  - Use the polishing liquid only on the polished surfaces of the cabinet. Always wipe the surface with the grain using straight, even strokes. Do not repeatedly wipe the same places using too much pressure, since that might result in the loss of luster.
  - Be sure to keep the polishing liquid out of the reach of small children. If the polishing liquid is accidentally swallowed, first get them to vomit, then take them to a doctor.

## Repairs and Data

- Please be aware that all data contained in the unit's memory may be lost when the unit is sent for repairs. Important data should always be backed up USB flash drives, or written down on paper (when possible). During repairs, due care is taken to avoid the loss of data. However, in certain cases (such as when circuitry related to memory itself is out of order), we regret that it may not be possible to restore the data, and Roland assumes no liability concerning such loss of data.

## Additional Precautions

- Please be aware that the contents of memory can be irretrievably lost as a result of a malfunction, or the improper operation of the unit. To protect yourself against the risk of losing important data, we recommend that you periodically save a backup copy of important data you have stored in the unit's memory on a USB flash drive.
- Unfortunately, it may be impossible to restore the contents of data that was stored in the unit's memory, USB flash drives once it has been lost. Roland Corporation assumes no liability concerning such loss of data.
- Use a reasonable amount of care when using the unit's buttons, sliders, or other controls; and when using its jacks and connectors. Rough handling can lead to malfunctions.
- Never strike or apply strong pressure to the display.
- When connecting / disconnecting all cables, grasp the connector itself—never pull on the cable. This way you will avoid causing shorts, or damage to the cable's internal elements.
- A small amount of heat will radiate from the unit during normal operation.
- To avoid disturbing your neighbors, try to keep the unit's volume at reasonable levels. You may prefer to use headphones, so you do not need to be concerned about those around you.
- The sound of keys being struck and vibrations produced by playing an instrument can be transmitted through a floor or wall to an unexpected extent. In particular, when using headphones, please take care not to cause annoyance to others nearby.
- When you need to transport the unit, pack it in shock-absorbent material. Transporting the unit without doing so can cause it to become scratched or damaged, and could lead to malfunction.
- Do not apply undue force to the music stand while it is in use.
- Some connection cables contain resistors. Do not use cables that incorporate resistors for connecting to this unit. The use of such cables can cause the sound level to be extremely low, or impossible to hear. For information on cable specifications, contact the manufacturer of the cable.
- Before opening or closing the keyboard lid, always make sure that no pets or other small animals are located on top of the instrument (in particular, they should be kept away from the keyboard and its lid). Otherwise, due to the structural design of this instrument, small pets or other animals could end up getting trapped inside it. If such a situation is encountered, you must immediately switch off the power and disconnect the power cord from the outlet. You should then consult with the retailer from whom the instrument was purchased, or contact the nearest Roland Service Center.

### Before Using USB Memories

(Using Optional USB flash drive)

- Do not connect or disconnect USB flash drive while it is being read from, or written to (i.e., while the USB flash drive access indicator will blink).
- Carefully insert the USB flash drives all the way in—until it is firmly in place.

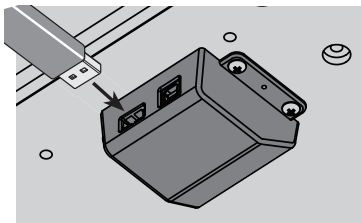

- Never touch the terminals of the USB flash drives. Also, avoid getting the terminals dirty.
- USB flash drives are constructed using precision components; handle the USB flash drives carefully, paying particular note to the following.
  - To prevent damage to the USB flash drives from static electricity, be sure to discharge any static electricity from your own body before handling the USB flash drives.
  - Do not touch or allow metal to come into contact with the contact portion of the USB flash drives.
  - Do not bend, drop, or subject USB flash drives to strong shock or vibration.
  - Do not keep USB flash drives in direct sunlight, in closed vehicles, or other such locations.
  - Do not allow USB flash drives to become wet.
  - Do not disassemble or modify the USB flash drives.

### Handling CDs / DVDs

(Using Optional CD-Drive)

- Avoid touching or scratching the shiny underside (encoded surface) of the disc. Damaged or dirty discs may not be read properly. Keep your discs clean using a commercially available disc cleaner.

- Recording, duplication, distribution, sale, lease, performance, or broadcast of copyrighted material (musical works, visual works, broadcasts, live performances, etc.) belonging to a third party in part or in whole without the permission of the copyright owner is forbidden by law.
- Do not use this product for purposes that could infringe on a copyright held by a third party. We assume no responsibility whatsoever with regard to any infringements of third-party copyrights arising through your use of this product.
- The copyright of content in this product (the sound waveform data, style data, accompaniment patterns, phrase data, audio loops and image data) is reserved by Roland Corporation and/or Atelier Vision Corporation.
- Purchasers of this product are permitted to utilize said content for the creating, performing, recording and distributing original musical works.
- Purchasers of this product are NOT permitted to extract said content in original or modified form, for the purpose of distributing recorded medium of said content or making them available on a computer network.
- MMP (Moore Microprocessor Portfolio) refers to a patent portfolio concerned with microprocessor architecture, which was developed by Technology Properties Limited (TPL). Roland has licensed this technology from the TPL Group.
- XG (XG) is a registered trademark or a trademark of Yamaha Corporation.
- XGLite (XGLite) is a registered trademark or a trademark of Yamaha Corporation.
- Company names and product names appearing in this document are registered trademarks or trademarks of their respective owners.

## About the Ivory Feel Keyboard

### Features of an ivory feel keyboard

Traditional piano keys are made from the best materials—ivory (for white keys) and ebony (for black keys). The Ivory Feel keyboard uses the latest in technology to reproduce the touch and feel of these materials.

An Ivory Feel keyboard offers the following features.

- We're sure you'll develop a fondness for the distinctive texture of these keys, which feels better the more you play them.
- Surfaces incorporate stripes of moisture-absorbing material for improved touch and playability.
- The keys feature subtle gloss and understated coloring, enhancing the look and elegance.
- The white keys are finished with a slight yellowish tinge for the look of real ivory.

### Handling

- Do not write on the keyboard with any pen or other implement, and do not stamp or place any marking on the instrument. Ink will seep into the surface lines and become unremovable.
- Do not affix stickers on the keyboard. You may be unable to remove stickers that use strong adhesives, and the adhesive may cause discoloration.

### Care and maintenance

Please note the following points. Failure to do so may result in scratches on the surface finish, damaged gloss, or other discoloration or deformation.

- To remove dirt, use a soft cloth. Using a moistened and tightly wrung-out cloth, gently wipe off any dirt. Do not rub the surface vigorously.
- To remove stubborn dirt, use a commercially available keyboard cleaner that does not contain abrasives. Start by wiping lightly. If the dirt does not come off, wipe using gradually increasing amounts of pressure while taking care not to scratch the keys.
- Do not use benzene, paint thinner, or alcohol on the instrument.

# Assembling

- \* To move the piano, lift it carefully—all the while keeping it level.
- \* Be very careful, when you assemble and move the piano, to make sure that you do not drop it on your hands or feet.
- \* Make sure to enlist the help of at least one other person when assembling this unit and moving it to a different location.
- \* Make sure to keep screws and any other small parts in a safe location that is out of the reach of small children, so such small parts won't accidentally get swallowed.
- \* The screwdriver needed to perform the assembly is not supplied. You'll need to have ready a Phillips screwdriver that matches the size of the screws.
- \* All screws should be tightened provisionally first, then tightened later. To tighten a screw provisionally, screw it in until about half of its length is no longer visible. Do not use an electric screwdriver when tightly securing the screws. Otherwise, you risk stripping the threads.
- \* After firmly tightening all the screws, place the unit at a location that is level and sure to remain stable. The unit must never be placed on top of deep-pile carpet. Otherwise, you risk causing damage to the pedals due to instability and unnecessary movement.
- \* The piano unit and the surface of the stand are very delicate; handle with care to avoid scratching them.
- \* Do not place the piano unit directly on the floor. Doing so will damage the bottom panel case and the connectors and holders on the bottom of the piano.

## Parts Check

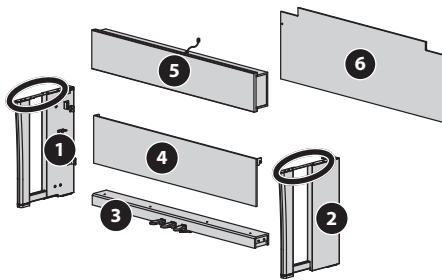

- 1 Side Board (left)
- 2 Side Board (right)
- 3 Pedal Board
- 4 Front Board
- 5 Speaker Box
- 6 Rear Board

- A Screw (M6 × 40 mm) x 4
- B Screw (M5 × 20 mm) x 10
- C Thumbscrew x 4 (two of them are already attached to the unit)
- D Screw (M4 × 16 mm) x 2
- E Headphone Hook x 1

\* You will also need to have Phillips screwdrivers (size: #2, #3).

\* When handling the side boards, avoid touching the metal portions marked with  in the figure.

## 1. Assembly Procedure

- \* At first, assemble the entire stand in a temporary fashion, without really tightening the screws. Then, after checking the overall alignment of the boards (and gently shifting certain parts where necessary), go around and tightly fasten each of the screws.
- \* If necessary, spread out a blanket or similar material to prevent the stand or floor from being scratched during assembly.
- \* Be careful not to pinch the pedal cord during assembly.

**1.** As shown in the illustration, place the left and right side boards on the pedal board so that the metal brackets are on the inside, and fasten them provisionally using screws **A** (M6 x 40 mm).

**2.** After you have provisionally tightened screws **A** (four locations), use a screwdriver to tighten them firmly.

- \* When attaching the pedal board, do not allow any gap to remain between the side board and pedal board when the pieces are assembled.

As seen from the bottom

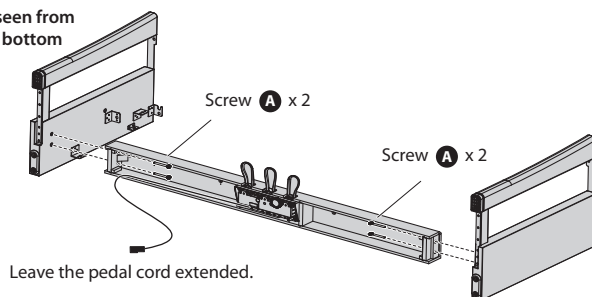

**3.** With the help of another person, raise the left and right side boards to an upright position.

- \* Take care that the pedal boards are not twisted.

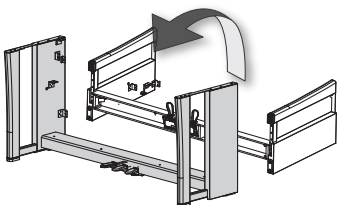

**4.** Loosen the screws attached to the left and right side boards approximately three turns, so that they protrude about 3 mm, as shown in the illustration.

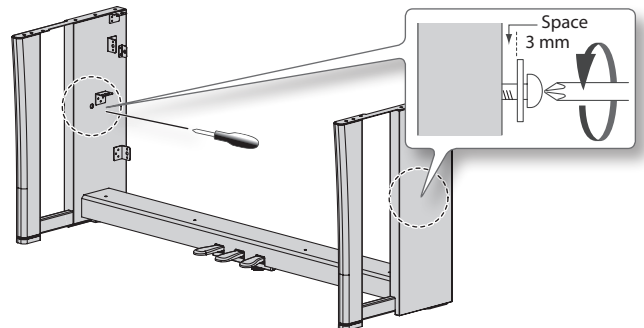

**5.** Hook the metal brackets of the front board over the screws you loosened, as shown in the illustration.

**6.** Use four screws **B** (M5 x 20 mm) to provisionally fasten the pedal board.

Rear view

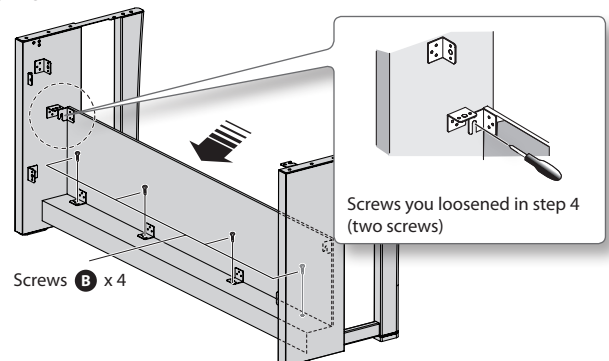



**7. Securely tighten the two side board screws and four pedal board screws.**

\* When attaching the front board, before tightening the screws, adjust things as necessary at all the points where there are screws so as to assure that the front board is aligned in parallel with the pedal board.

**8. Set the speaker box so that the speaker cable is above it, and align the holes in the metal parts on the inner side of the side boards with the holes in the speaker box.**

**9. Attach the speaker box to the metal parts on the inside of the side boards from underneath using screws **B** (M5 x 20 mm). Then fasten the rear with screws **B** (M5 x 20 mm) as well.**

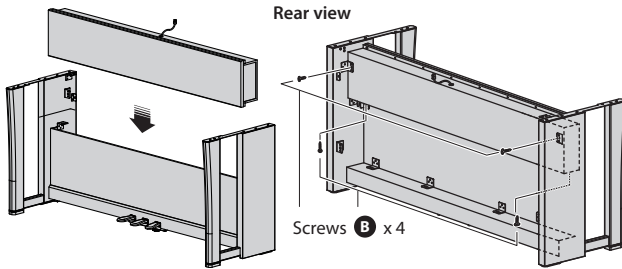

## 2. Install the Piano onto the Stand

**1. Align the two screws at the bottom of the piano (one each at left and right) with the metal fixtures on the side boards, then while slightly lifting the front end of the piano, push it toward the rear, while making sure that the screws have been properly grasped by the metal fixtures.**

\* When handling the piano, firmly grasp it. Be careful, so you do not get your fingers pinched.

**2. Fasten the piano to the stand with the screw **B** (M5x20 mm).**

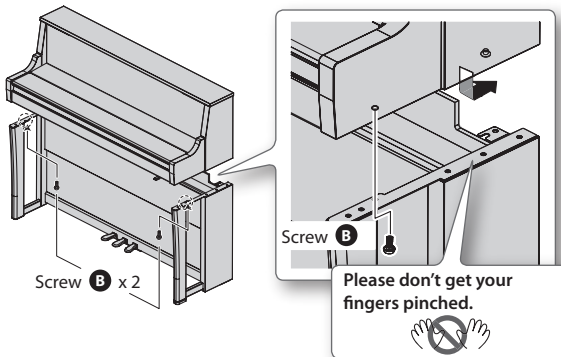

**3. Connect the speaker cable to the speaker connector on the bottom of the main unit, connect the AC cord to the AC In connector on the bottom of the main unit, and connect the pedal cord to the Pedal jack.**

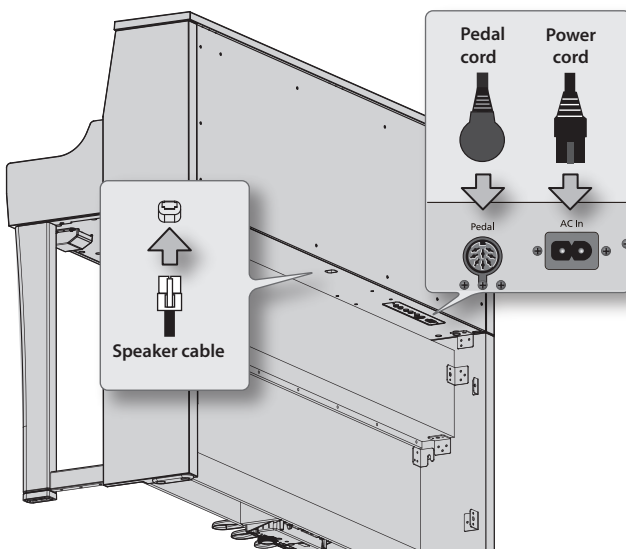

**4. Loosen the two thumbscrews **C** that are attached at the locations shown in the figure. As illustrated, you should create gaps that are about 10 mm in size.**

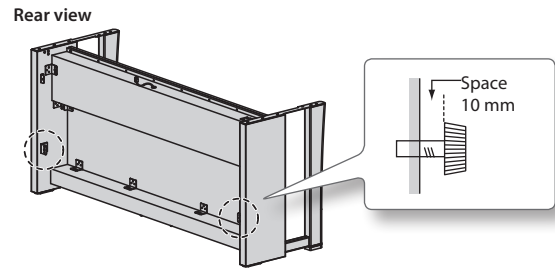

**5. Attach the rear board by hooking it onto the gaps left by the screws, as shown in the figure.**

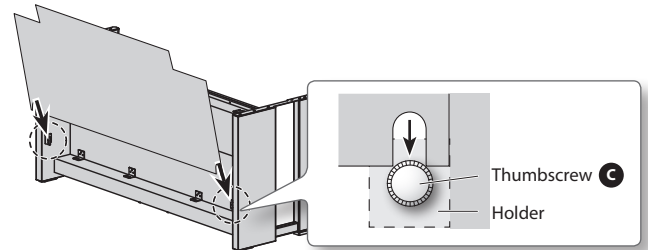

**6. Use two of the thumbscrews **C** to fasten the rear board.**

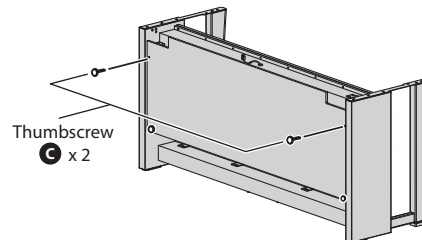

**7. Securely tighten the thumbscrews **C** that were loosened in step 4, as well as the thumbscrews **C** that were used to fasten the rear board in step 6.**

\* The screws can be more securely tightened if you raise the rear board slightly.

**8. Fasten the headphone hook using screws **D** (M4 x 16 mm).**

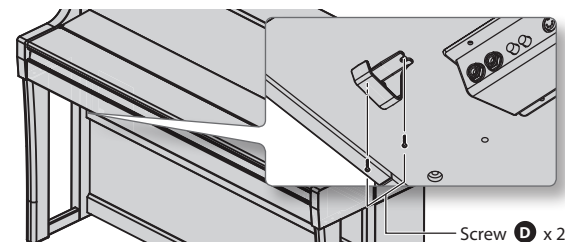

## 3. Adjusting the Adjuster

Turn the adjuster to lower it until the adjuster is in firm contact with the floor. In particular, when you've placed the piano on carpet, you must turn the adjuster until it is pressing firmly against the floor.

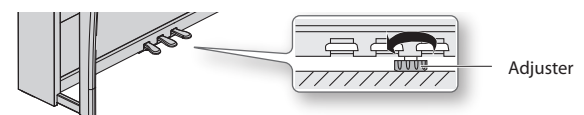

\* The pedal may be damaged if there is a gap between the adjuster and the floor.

### When Moving the Piano

When you need to move the unit, you should first close the keyboard cover, close the lid, detach the AC cord, and raise the adjusters of the stand. When moving the unit, at least two people should work together and lift the unit carefully, all the while keeping it level, and being very careful so as not to drop the unit on anyone's feet.

# Index

<b>A</b>
AB Repeat ..... 9, 27
Accompaniment part ..... 26
AC In (AC Inlet)..... 11
All Songs Play..... 25
Ambience ..... 6, 18
[Ambience] button..... 18
Assembling..... 58
Audio Recording..... 34
Audio Transpose..... 35, 45
Auto Off..... 40
<b>B</b>
Brilliance ..... 6, 19
[Brilliance] button..... 19
[ ◀▶ ] (Bwd) button..... 24
<b>C</b>
Cabinet Resonance ..... 39
CD/Audio Type..... 47
CD Drive..... 47
Center Cancel..... 35, 45
Center Pedal..... 46
Converting a Song ..... 33
Copy Song..... 41
Count-in..... 23
CZERNY..... 24
<b>D</b>
Damper Noise ..... 39
Damper Pedal ..... 10
Damper Pedal Part ..... 45
Damper Resonance ..... 38
Delete Song ..... 42
Display ..... 8
Display Contrast ..... 40
Dual Balance..... 44
Dual Play ..... 15
Duplex Scale..... 38
<b>E</b>
Effects..... 15

[E. Piano] button ..... 14
Erasing ..... 29
<b>F</b>
Factory Reset ..... 41
[▶] (Fast) button ..... 22
FAVORITE ..... 24
Format Media..... 42
Function Mode ..... 44
[ ▶▶ ] (Fwd) button ..... 24
<b>H</b>
Hammer Noise..... 38
Hammer Response..... 38
HANON..... 24
Headphone hook ..... 10
<b>I</b>
Input jacks..... 11
Input Volume ..... 44
Internal Song List ..... 53
Ivory Feel Keyboard..... 57
<b>K</b>
Key Off Resonance ..... 39
Key Touch ..... 6, 19
<b>L</b>
Left-hand part ..... 26
Lid..... 12, 38
Local Control ..... 46
<b>M</b>
Master Gain..... 44
MASTERPIECE..... 24
Master Tuning ..... 39, 44
Memory Backup ..... 6, 40
Metronome..... 8, 22
[Metronome] button ..... 22
Metronome's Volume ..... 23
MIDI Out/In connectors ..... 11
MIDI Transmit Channel ..... 46
MIDI Visual Control..... 48

Music Rest..... 12
Mute Volume ..... 26
Muting ..... 26
<b>O</b>
Octave Shift ..... 45
[Other] button ..... 14
Output jacks..... 11
Overdubbing ..... 30
<b>P</b>
Panel Lock ..... 9, 43
Part..... 26
Part Mute..... 26
Pedal connector ..... 11
Phones jacks..... 11
Piano Designer..... 7, 38
Piano Designer Demo..... 39
Piano [Early] button..... 14
Piano [Grand] button..... 14
Playback..... 9
Playing a Song ..... 24
[ ▶/■ ] (Play/Stop) button ..... 24
Power On/Off..... 13
[Power] switch ..... 10
<b>R</b>
[ ● ] (Rec) button..... 24
Recording ..... 9, 28
Recording Mode..... 45
[ ◀ ] (Reset) button ..... 24
Right-hand part..... 26
Rotary effect..... 14
<b>S</b>
Saving..... 29, 37
Selecting a Song ..... 8, 24
[ ◀ ] (Slow) button ..... 22
SMF Recording..... 28
Soft Pedal..... 10
Song Balance ..... 6, 25
[Song Balance] button ..... 25

[Song] button..... 24
Sostenuto Pedal ..... 10
Soundboard Behavior..... 38
Split Play..... 7, 16
Split Point ..... 17
Stretch Tuning ..... 39
String Resonance ..... 39
[Strings] button..... 14
<b>T</b>
Temperament..... 39, 44
Temperament Key ..... 39, 44
Temperaments..... 39
Tempo..... 8, 22, 25
Tempo Mute..... 25
Time Signature..... 8, 22
Tone Buttons ..... 7
Tone Demo ..... 14
Tone groups ..... 14
Tone List..... 52
Top Lid ..... 12
Transpose ..... 6, 21
[Transpose] button..... 21
Transpose Mode ..... 45
Twin Piano..... 7, 20
[Twin Piano] button..... 20
Twin Piano Mode ..... 20
<b>U</b>
USB..... 24
USB connector..... 11
USB Driver..... 47
USB memory connector..... 11
USB Memory Mode ..... 48
<b>V</b>
VIMA TUNES ..... 14
Visual Control Channel ..... 48
Visual Control Function Chart ..... 48
Visual Control Mode..... 48
V-LINK..... 48

# Error Messages

Indication	Meaning
<b>Error: 1</b>	You can only read the music file. It can not be saved.
<b>Error: 2</b>	An error occurred during writing. The external media may be corrupted. Insert other external media and try again. Alternatively, you can initialize the external media. The external media's protect tab may be in the "Protect" (writing prohibited) position may not yet be initialized.
<b>Error: 10</b>	No external media is inserted. Insert the external media and try again.
<b>Error: 11</b>	There is not sufficient free memory in the save destination. Either insert other external media or delete unneeded files and try again.
<b>Error: 14</b>	An error occurred during reading. The external media may be corrupted. Insert other external media and try again. Alternatively, you can initialize the external media.
<b>Error: 15</b>	The file is unreadable. The data format is not compatible with the LX-15.
<b>Error: 16</b>	Data was not called up in time for playback of the song. After waiting several seconds, you may be able to play back the song by pressing the [ ▶/■ ] (Play/Stop) button again.
<b>Error: 18</b>	This audio format is not supported. Please use 44.1 kHz 16-bit linear WAV format audio files.
<b>Error: 30</b>	Internal memory capacity of the LX-15 is full.
<b>Error: 40</b>	The LX-15 cannot deal with the excessive MIDI data sent from the external MIDI device. Reduce the amount of MIDI data sent to the LX-15.
<b>Error: 41</b>	A MIDI cable has been disconnected. Connect it properly and securely.
<b>Error: 43</b>	A MIDI transmission error has occurred. Check the MIDI cable and connected MIDI device.
<b>Error: 51</b>	There may be a problem with the system. Repeat the procedure from the beginning. If it is not solved after you have tried several times, contact the Roland service center.
<b>Error: 65</b>	The USB flash drive connector was subjected to excessive current. Make sure that there is no problem with the external media, then turn the power off, then on again.

\* External Media: USB flash drive, CD-ROM, etc.

## For EU Countries



- UK** This symbol indicates that in EU countries, this product must be collected separately from household waste, as defined in each region. Products bearing this symbol must not be discarded together with household waste.
- DE** Dieses Symbol bedeutet, dass dieses Produkt in EU-Ländern getrennt vom Hausmüll gesammelt werden muss gemäß den regionalen Bestimmungen. Mit diesem Symbol gekennzeichnete Produkte dürfen nicht zusammen mit den Hausmüll entsorgt werden.
- FR** Ce symbole indique que dans les pays de l'Union européenne, ce produit doit être collecté séparément des ordures ménagères selon les directives en vigueur dans chacun de ces pays. Les produits portant ce symbole ne doivent pas être mis au rebut avec les ordures ménagères.
- IT** Questo simbolo indica che nei paesi della Comunità europea questo prodotto deve essere smaltito separatamente dai normali rifiuti domestici, secondo la legislazione in vigore in ciascun paese. I prodotti che riportano questo simbolo non devono essere smaltiti insieme ai rifiuti domestici. Ai sensi dell'art. 13 del D.Lgs. 25 luglio 2005 n. 151.
- ES** Este símbolo indica que en los países de la Unión Europea este producto deberá ser recogido aparte de los residuos domésticos, tal como está regulado en cada zona. Los productos con este símbolo no se deben depositar con los residuos domésticos.
- PT** Este símbolo indica que nos países da UE, a recolha deste produto deverá ser feita separadamente do lixo doméstico, de acordo com os regulamentos de cada região. Os produtos que apresentem este símbolo não deverão ser eliminados juntamente com o lixo doméstico.
- NL** Dit symbool geeft aan dat in landen van de EU dit product gescheiden van huishoudelijk afval moet worden aangeboden, zoals bepaald per gemeente of regio. Producten die van dit symbool zijn voorzien, mogen niet samen met huishoudelijk afval worden verwijderd.
- DK** Dette symbol angiver, at i EU-lande skal dette produkt opsamlles adskilt fra husholdningsaffald, som defineret i hver enkelt region. Produkter med dette symbol må ikke smides ud sammen med husholdningsaffald.
- NO** Dette symbolet indikerer at produktet må behandles som spesialavfall i EU-land, iht. til retningslinjer for den enkelte regionen, og ikke kastes sammen med vanlig husholdningsavfall. Produkter som er merket med dette symbolet, må ikke kastes sammen med vanlig husholdningsavfall.

- SE** Symbolen anger att i EU-länder måste den här produkten kasseras separat från hushållsavfall, i enlighet med varje regions bestämmelser. Produkter med den här symbolen får inte kasseras tillsammans med hushållsavfall.
- FI** Tämä merkintä ilmaisee, että tuote on EU-maissa kerättävä erillään kotitalousjätteistä kunkin alueen voimassa olevien määräysten mukaisesti. Tällä merkinnällä varustettuja tuotteita ei saa hävittää kotitalousjätteiden mukana.
- HU** Ez a szimbólum azt jelenti, hogy az Európai Unióban ezt a terméket a háztartási hulladéktól elkülönítve, az adott régióban érvényes szabályozás szerint kell gyűjteni. Az ezzel a szimbóllummal ellátott termékeket nem szabad a háztartási hulladék közé dobni.
- PL** Symbol oznacza, że zgodnie z regulacjami w odpowiednim regionie, w krajach UE produktu nie należy wyrzucać z odpadami domowymi. Produktów opatrzonych tym symbolem nie można utylizować razem z odpadami domowymi.
- CZ** Tento symbol udává, že v zemích EU musí být tento výrobek sbírán odděleně od domácího odpadu, jak je určeno pro každý region. Výrobky nesoucí tento symbol se nesmí vyhazovat spolu s domácím odpadem.
- SK** Tento symbol vyjadruje, že v krajinách EÚ sa musí zber tohto produktu vykonávať oddelene od domového odpadu, podľa nariadení platných v konkrétnej krajine. Produkty s týmto symbolom sa nesmú vyhazovať spolu s domovým odpadom.
- EE** See sümbol näitab, et EL-i maades tuleb see toode olemprügist eraldi koguda, nii nagu on igas piirkonnas määratletud. Selle sümboliga märgitud tooteid ei tohi ära visata koos olmeprügiga.
- LT** Šis simbolis rodo, kad ES šalyse šis produktas turi būti surenkamas atskirai nuo buitinių atliekų, kaip nustatyta kiekviename regione. Šiuo simboliu paženklinėti produktai neturi būti išmetami kartu su buitiniemis atliekomis.
- LV** Šis simbols norāda, ka ES valstīs šo produktu jāievāc atsevišķi no mājāsaimniecības atkritumiem, kā noteikts katrā reģionā. Produkts ar šo simbolu nedrīkst izmest kopā ar mājsaimniecības atkritumiem.
- SI** Ta simbol označuje, da je treba proizvod v državah EU zbirati ločeno od gospodinjjskih odpadkov, tako kot je določeno v vsaki regiji. Proizvoda s tem znakom ni dovoljeno odlagati skupaj z gospodinjjskimi odpadki.
- GR** Το σύμβολο αυτό υποδηλώνει ότι στις χώρες της Ε.Ε. το συγκεκριμένο προϊόν πρέπει να συλλέγεται χωριστά από τα υπόλοιπα οικιακά απορρίμματα, σύμφωνα με όσα προβλέπονται σε κάθε περιοχή. Τα προϊόντα που φέρουν το συγκεκριμένο σύμβολο δεν πρέπει να απορρίπτονται μαζί με τα οικιακά απορρίμματα.

## For China

## 有关产品中所含有害物质的说明

本资料就本公司产品中所含的特定有害物质及其安全性予以说明。

本资料适用于 2007 年 3 月 1 日以后本公司所制造的产品。

## 环保使用期限



此标志适用于在中国国内销售的电子信息产品，表示环保使用期限的年数。所谓环保使用期限是指在自制造日起的规定期限内，产品中所含的有害物质不致引起环境污染，不会对人身、财产造成严重的不良影响。环保使用期限仅在遵照产品使用说明书，正确使用产品的条件下才有效。不当的使用，将会导致有害物质泄漏的危险。

## 产品中有毒有害物质或元素的名称及含量

部件名称	有毒有害物质或元素					
	铅(Pb)	汞(Hg)	镉(Cd)	六价铬(Cr(VI))	多溴联苯(PBB)	多溴二苯醚(PBDE)
外壳(壳体)	×	○	○	○	○	○
电子部件(印刷电路板等)	×	○	×	○	○	○
附件(电源线、交流适配器等)	×	○	○	○	○	○

○：表示该有毒有害物质在该部件所有均质材料中的含量均在 SJ/T11363-2006 标准规定的限量要求以下。  
 ×：表示该有毒有害物质至少在该部件的某一均质材料中的含量超出 SJ/T11363-2006 标准规定的限量要求。  
 因根据现有的技术水平，还没有什么物质能够代替它。



For EU Countries

This product complies with the requirements of EMCD 2004/108/EC and LVD 2006/95/EC.

For the USA

## FEDERAL COMMUNICATIONS COMMISSION RADIO FREQUENCY INTERFERENCE STATEMENT

This equipment has been tested and found to comply with the limits for a Class B digital device, pursuant to Part 15 of the FCC Rules. These limits are designed to provide reasonable protection against harmful interference in a residential installation. This equipment generates, uses, and can radiate radio frequency energy and, if not installed and used in accordance with the instructions, may cause harmful interference to radio communications. However, there is no guarantee that interference will not occur in a particular installation. If this equipment does cause harmful interference to radio or television reception, which can be determined by turning the equipment off and on, the user is encouraged to try to correct the interference by one or more of the following measures:

- Reorient or relocate the receiving antenna.
- Increase the separation between the equipment and receiver.
- Connect the equipment into an outlet on a circuit different from that to which the receiver is connected.
- Consult the dealer or an experienced radio/TV technician for help.

This device complies with Part 15 of the FCC Rules. Operation is subject to the following two conditions:

- (1) this device may not cause harmful interference, and
- (2) this device must accept any interference received, including interference that may cause undesired operation.

This equipment requires shielded interface cables in order to meet FCC class B limit.

Any unauthorized changes or modifications not expressly approved by the party responsible for compliance could void the user's authority to operate the equipment.

For Canada

### NOTICE

This Class B digital apparatus meets all requirements of the Canadian Interference-Causing Equipment Regulations.

### AVIS

Cet appareil numérique de la classe B respecte toutes les exigences du Règlement sur le matériel brouilleur du Canada.

For C.A. US (Proposition 65)

### WARNING

This product contains chemicals known to cause cancer, birth defects and other reproductive harm, including lead.

For the USA

## DECLARATION OF CONFORMITY Compliance Information Statement

Model Name : LX-15  
Type of Equipment : Digital Piano  
Responsible Party : Roland Corporation U.S.  
Address : 5100 S. Eastern Avenue, Los Angeles, CA 90040-2938  
Telephone : (323) 890-3700





Roland

